



2-PORT VECTOR  
NETWORK ANALYZER

**ARINST VNA-PR1**  
**1-6200 MHz**

MANUAL



## CONTENT

1. PURPOSE .....	4
2. SAFETY RULES FOR WORKING WITH THE DEVICE .....	4
2.1. General safety requirements.....	4
2.2. Additional safety requirements.....	4
3. SPECIFICATIONS .....	5
4. COMPLETENESS.....	6
5. STRUCTURE OF THE DEVICE .....	6
6. DESCRIPTION AND OPERATION OF THE DEVICE .....	7
7. START ON.....	9
8. SCREEN INTERFACE .....	9
9. DEVICE MENU .....	11
9.1. Main menu .....	11
9.2. Setting the frequency range parameters .....	11
9.3. Setting parameters for measuring distance to fault.....	13
9.4. Device calibration menu .....	15
9.5. Information about the device.....	17
9.6. Compensation electrical length of the cable .....	17
9.7. Shift of the amplitude scale on plots Lin. Amp and Log. Amp .....	19
9.8. Adjusting the output power of the probe signal generator .....	20
9.9. Displaying the SWR limit line .....	20
9.10. Configuring plot parameters.....	20
9.12. User settings menu.....	25
9.13. Saving measurement results.....	26
10. CHARTS AND PLOTS .....	29
10.1. Smith chart.....	29
10.2. Polar chart.....	29
10.3. Phase plot .....	30
10.4. Plot of the magnitude (modulus) of the reflection coefficient on a linear scale.....	31
10.5. Plot of the magnitude (modulus) of the reflection coefficient on a logarithmic scale .....	31
10.6. VSWR plot.....	32
10.7. Measuring the distance to fault .....	32
10.8. Cable loss plot.....	33
10.9. Group delay plot.....	34
11. CARE AND MAINTENANCE .....	36
11.1. General care of the device.....	36
11.2. Battery charging .....	36
11.3. Battery replacement .....	36
11.4. Keeping.....	38
11.6. Limit state criterion .....	38
11.7. Utilization .....	38
12. POSSIBLE MALFUNCTIONS AND METHODS OF THEIR ELIMINATION.....	39

13. RETURN THE DEVICE TO FACTORY SETTINGS .....	40
14. WARRANTY .....	41
APPLICATION A. ARINST VNA-PR1 vector network analyzer software update .....	42

## 1. PURPOSE

1.1. Portable 2-port vector network analyzer **ARINST VNA-PR1** (analyzer, device) is designed to measure the elements of the scattering matrix (complex reflection and transmission coefficients) of four-port networks. The device measures parameters S11 and S21, voltage standing wave ratio (VSWR), impedance, admittance, phase, group delay (GD), distance to cable fault.

1.2. The analyzer is designed for setting and matching the characteristics of passive and active radio devices<sup>1</sup> (antennas, cables, filters, attenuators, amplifiers), checking the integrity of high-frequency cables, measuring their parameters, and other amateur radio measurements.

1.3. The device is intended for amateur radio applications, as it is not a professional measuring instrument. The built-in battery allows you to make measurements in the laboratory and in the practical conditions.

## 2. SAFETY RULES FOR WORKING WITH THE DEVICE

### 2.1. General safety requirements

2.1.1. Persons who have read this «Manual» and have been instructed in the rules of safe work with electrical appliances are allowed to work with the device.

2.1.2. The risk of injury is possible when the charger is connected or disconnected from the electrical network. Use serviceable power outlets and chargers.

2.1.3. To avoid damage to the wires and connectors of the device, do not hang anything on the wires, paint over and glue the wires and connectors, disconnect the wires by pulling the cord.

2.1.4. Persons using the device are strictly prohibited: pass the device to strangers, disassemble and carry out any repairs not agreed with the manufacturer, use a device with a damaged case.

2.1.5. If you find a fault, stop operation immediately and turn off the device.

2.1.6. If you need to leave your workplace, turn off the device and other devices. Do not leave the working device unattended!

2.1.7. Do not use the device in hospitals. The use of the device near medical equipment is allowed only with the consent of the medical staff.

### 2.2. Additional safety requirements

2.2.1. Use the device only for its intended purpose. Read the purpose, device, and technical characteristics of the device.

2.2.2. Avoid working in open spaces during snow or rain. High humidity and all types of liquid, getting inside the device, can damage it.

2.2.3. Do not expose the device to very low or very high temperatures, exposure to extreme temperatures can damage the built-in battery.

2.2.4. Do not use the device in areas with a corrosive or explosive environment. Aggressive vapors can destroy the insulation, which can cause the device to fail.

2.2.5. Do not apply excessive force to the device's connectors, controls, or screen. Avoid bumps and falls on the device. If the device falls, it may be damaged.

2.2.6. Do not disassemble or modify the device without the consent of the manufacturer or without the instructions described in this manual. Incorrect self-intervention in the device will result in loss of warranty.

2.2.7. Use chargers, cords, adapters, and other accessories recommended by the manufacturer.

2.2.8. When connecting other tools to the device, carefully read their purpose, technical characteristics. Do not connect incompatible devices.

2.2.9. Maintenance and repair of the device must only be performed by the manufacturer or an authorized service center.

---

<sup>1</sup> The devices must allow the possibility of applying a stimulating signal from the analyzer to the test port. The analyzer manufacturer is not responsible for the failure of devices that do not allow the supply of a stimulating signal to the test port.

### 3. SPECIFICATIONS

3.1. The technical characteristics of the device are shown in Table 1.

Table 1

Parameter		Value
Operating frequency range		1-6200 MHz
Frequency resolution	for range 1-100 MHz	100 Hz
	for range 100-6200 MHz	10 kHz
Maximum number of scan points		1000
Scanning rate		1000 points / s
Dynamic range S21 (BW = 250 Hz)	for range 1-1,5 MHz	> 60 dB, 70 dB (typ.)
	for range 1,5-4500 MHz	> 80 dB, 90 dB (typ.)
	for range -6200 MHz	> 70 dB, 75 dB (typ.)
The direction of the bridge, uncorrected throughout the range, not less		12 dB
Directivity effective <sup>2</sup> (after full one-port calibration), not less		55 dB
Input standing wave ratio, not more		2
Phase measurement error <sup>2</sup> , not more		0,7°
Magnitude measurement error <sup>2</sup> , not more		0,25 dB
Resolution for determining the distance to fault <sup>3</sup>		$(C \times VF)/2S$ m
Maximum length of the measured cable <sup>4</sup> , when VF=1		3000 m
Compensation electrical length of the cable, when VF=1		±3 m
Maximum DC Input Voltage		25 V
Maximum input power supplied to the ports		+10 dBm
Maximum power of the probing signal <sup>5</sup> , not more		-5 dBm
Displayed charts	<ul style="list-style-type: none"> <li>■ Smith chart; ■ polar chart; ■ phase of the reflection coefficient S11 and transmission coefficient S21; ■ magnitude of S11 and S21 ; ■ logarithmic magnitude of S11 and S21; ■ SWR; ■ distance to fault; ■ cable loss; ■ group delay</li> </ul>	
Number of user settings to save		32
Number of traces to save		32
Operating temperature range		0 ... +40°C
Screen diagonal		4"
Screen type		touch resistive
Screen resolution		800×480
Test port connectors type		SMA (female)
Maximum current consumption, no more	when charging the battery	≤ 2 A <sup>6</sup>
	when working on battery power	~ 1 A
	when working from USB with battery charging <sup>7</sup>	≤ 2 A <sup>6</sup>
Battery capacity		5000 mAh
Time of continuous battery life <sup>8</sup>		2,5 h
Battery charge time <sup>8</sup>		~ 3,5 h
Overall dimensions (L × W × H)		150×81×27 mm
Weight		0,4 kg

<sup>2</sup> The measurement is performed after warming up the device for at least five minutes with a full calibration. The change in ambient temperature from the moment of calibration to measurements should not exceed ± 3 ° C.

<sup>3</sup> Where **C** is the speed of light m/s; **VF** – velocity factor (the ratio of the speed of propagation of electromagnetic waves in the cable to the speed of propagation of electromagnetic waves in a vacuum), takes a value from 0.1 to 1 (depending on cable); **S** - scanning frequency range (Hz).

<sup>4</sup> Depends on the amount of attenuation in the cable and is the indication limit on the display.

<sup>5</sup> With the possibility of reducing.

<sup>6</sup> When connecting the device to a charger with an output current of at least 3A.

<sup>7</sup> If your PC has a limit on the maximum current supplied to the USB port, the device will automatically limit the maximum charging current according to the current USB specification.

<sup>8</sup> At an ambient temperature of 20±5°C after the battery is fully charged.

## 4. COMPLETENESS

4.1. The delivery set of the device is shown in Table 2.

Table 2

Name	Quantity
The vector network analyzer ARINST VNA-PR1 1-6200 MHz	1 pc.
USB 2.0 – Mini-USB cable	1 pc.
SMA (female) – SMA (female) adapter	2 pc.
Manual (product passport)	1 pc.
Package	1 pc.

**Due to the continuous improvement of the device and software, the manufacturer reserves the right to make changes to its technical characteristics and completeness.**

## 5. STRUCTURE OF THE DEVICE

5.1. The device structure is shown in Figure 5.1.

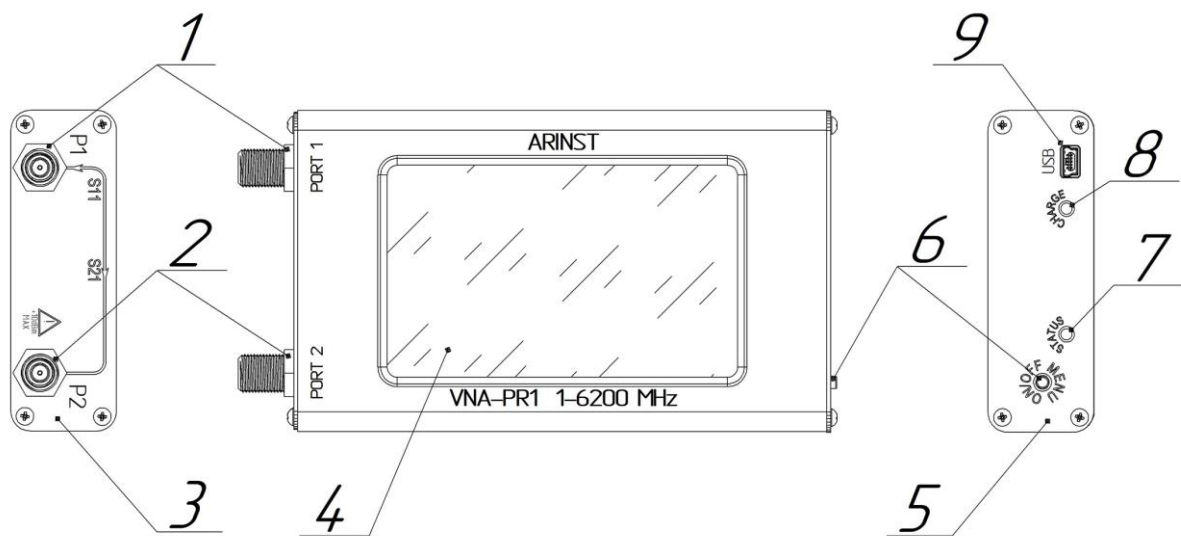

Figure 5.1 - External view of the device

- 1. Measuring port 1 (PORT 1)** is intended for connecting the test devices and acts as a source and receiver of the signal.
- 2. Measuring port 2 (PORT 2)** is intended for connecting the test devices and is a signal receiver.
- 3. High frequency connector panel**
- 4. Color resistive screen 4"** serves to configure the device through the on-screen menu and display measurement results in the form of user-defined plots and charts.
- 5. Indication panel**
- 6. Multi-function button.** Turns on and off the device when pressed and held for more than 2 seconds. When pressed once, it opens or hides the main menu of the device.
- 7. Indicator STATUS.** Lights up when the device is on.
- 8. Battery charging indicator CHARGE.** Lights up when the battery is charging and when the device is operating from USB. Turns off when charging is complete.
- 9. Connector Mini-USB.** Serves for data transmission and battery charging of the device.

### 6. DESCRIPTION AND OPERATION OF THE DEVICE

Vector network analyzer **ARINST VNA-PR1** is a technically complex measuring device consisting of a test (probe) signal generator, directional couplers, a multichannel receiver, ADC, a microcontroller, LCD and a Li-Ion battery.

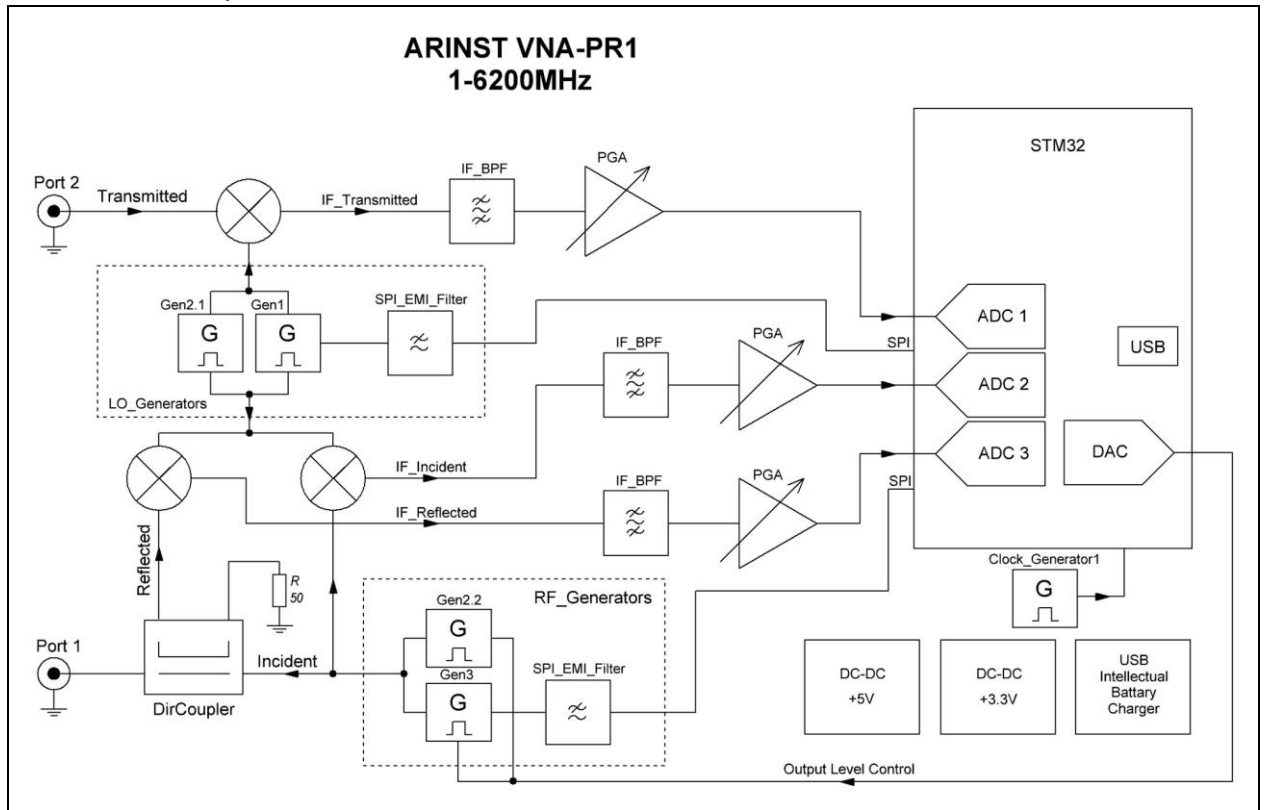

Figure 6.1 - Block diagram of the ARINST VNA-PR1

This is a portable device consisting of the main unit and its accessories (measuring cables, connectors, adapters, calibration tools).

The analyzer performs the functions of forming a probing signal, measuring, calculating and displaying the measured parameters of the test device.

The analyzer provides adjustment of the output power level of the probing signal generator. Power adjustment extends the measurement capabilities of active devices and reduces the probability of exceeding the maximum power of the input signal of the P2 port specified in the technical characteristics of the device.

where,

- ARINST VNA-PR1** – network analyzer;
- DUT** – device under test;
- P1** and **P2** – port 1 and port 2 of the analyzer;
- $U_{rwa}$  – reflected wave amplitude;
- $U_{iwa}$  – incident wave amplitude;
- $U_{twa}$  – transmitted wave amplitude.

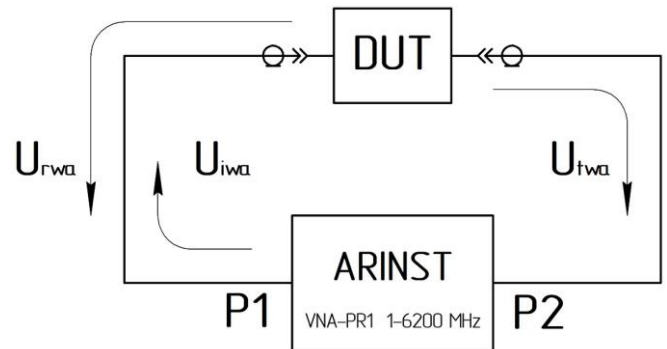

Figure 6.2 - Schematic diagram of measurements of the reflection and transmission coefficient

The device generates a probing signal based on the frequency range set by the user.

In measurement mode S11 the probing signal (incident wave) is sent to the first port P1, to which the test device or calibration standards are connected. A reflected wave is formed, which is separated by a directional coupler and enters the reflected signal receiver. From the output of the receiver, the intermediate frequency (IF) signal is converted into digital form using a high-speed ADC. The digitized data contains information about the amplitude and phase of the reflected signal. Similarly, information about the amplitude and phase of the incident signal is obtained.

At each frequency, the IF signal of the direct and reflected waves is sampled with further calculation of the amplitude and phase of each signal using the maximum likelihood method.

The obtained values make it possible to calculate the reflection coefficient (RC), which is a complex number that carries information about both the phase and the amplitude of the reflected and incident waves.

$$RC = \frac{U_{rwa}}{U_{iwa}} \times \exp[j(\varphi_{rwp} - \varphi_{iwp})]$$

where,  $U_{rwa}$  – Reflected wave amplitude;

$U_{iwa}$  – Incident wave amplitude;

$\Phi_{rwp}$  – Reflected wave phase;

$\Phi_{iwp}$  – Incident wave phase;

$j$  –  $\sqrt{-1}$  – Imaginary unit.

In measurement mode S21 the probing signal (incident wave) is sent to the first port P1. The test device is connected to port P1 on one side and to port P2 on the other. In this mode, the analyzer can simultaneously measure the parameters S11 (according to the algorithm described above) and S21. When measuring S21, the incident wave passes through the test device, the resulting signal enters port P2 and enters the processing path of the transmitted signal, is transferred to IF and converted to digital form using an ADC.

The obtained values make it possible to calculate the transmission coefficient (TC), which is a complex number that carries information about both the phase and the amplitude of the transmitted wave.

$$TC = \frac{U_{twa}}{U_{iwa}} \times \exp[j(\varphi_{twp} - \varphi_{iwp})]$$

where,  $U_{twa}$  – Transmitted wave amplitude;

$U_{iwa}$  – Incident wave amplitude;

$\Phi_{twp}$  – Transmitted wave phase;

$\Phi_{iwp}$  – Incident wave phase;

$j$  –  $\sqrt{-1}$  – Imaginary unit.

After calculating the RC and TC, the microcontroller displays the result of scanning over the frequency range in the form of plots and charts selected by the user: Smith chart, phase chart, magnitude plot of RC / TC, SWR plot and others.



## 7. START ON

 **Do not use the device outdoors during snowfall or rain. If the device is brought in during the cold season from a cold room or from the street into a warm room, do not turn it on for enough time to allow condensation to evaporate from the device.**

 **Match the signal strength and voltage applied to ports P1 and P2 to the maximum device specifications shown in Table 1.**

7.1. Make sure that the device is not damaged externally and that the battery is charged. Charge the discharged battery in accordance with item 11.2.

7.2. Press and hold button (6) for 2 seconds. The device turns on. When the device is turned on for the first time, it is necessary to set the frequency range, the type of plots displayed on the screen (4) and carry out calibration. User settings will be saved in the device memory and will be automatically installed on subsequent switching on.

7.3. To turn off the device, press and hold the button (6) for 2 seconds. The display (4) of the device will go out, the device will turn off. Each time the device is turned off, the main user settings are recorded in the nonvolatile memory, which allows avoiding the device setting at the next turn on.

## 8. SCREEN INTERFACE

The device displays the results of scanning the frequency range specified by the user in the form of plots and charts. The current device settings and interactive buttons for controlling the device interface are located at the bottom of the screen.

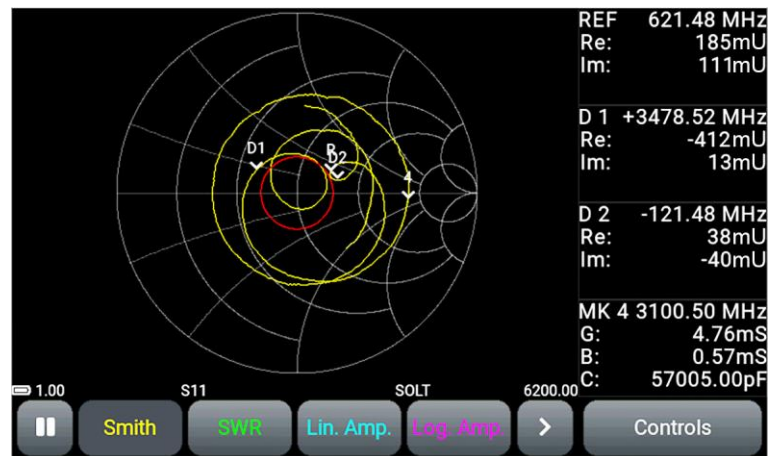

Figure 8.1 - Device screen

8.1. The information bar of the screen displays information about the current state of the device.

8.1.1. Built-in battery status indicator:

- indicator in the form of a spark (lightning) – the battery is charging;
- the battery indicator symbol is completely filled in white – the battery is fully charged;
- indicator symbol in the form of a white battery outline – the battery is low and needs to be charged;
- the device displays a message about the critical charge level – the battery is fully discharged, the device will automatically turn off.

8.1.2. Frequency range:

- Numerical values of the beginning and end of the frequency range. In our example, the frequency range is 1-6200 MHz.

In the mode of measuring the distance to fault, instead of the frequency range, the distance in meters or time in nanoseconds is displayed.

8.1.3. Measurement mode:

- **S11** – the mode of measuring the reflection coefficient, cable loss and distance to damage;



- **S21** – transmission coefficient measurement mode.

8.1.4. Calibration type designation:







- **Factory** – factory calibration;
- **SOL** – one-port calibration;
- **SOL+T** – full two-port calibration;
- **T** – direct connection.

8.2. The interface control buttons are located under the information bar (figure 8.1):

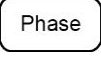

8.2.1. The «pause» button. Pressing the button pauses the measurement process and «freezes» the plot on the screen. Pressing the button again resumes the measurement process.

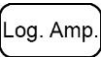
-  – pause off, measurement in progress;
-  – pause on, measurement is paused.

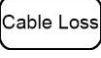
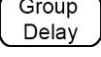
8.2.2. Buttons for switching charts. The device screen displays buttons for quick access to four plots with measurement results simultaneously. The chart types and their order in the row are set by the user.

-  – Smith chart or impedance chart;
-  – polar chart;
-  – the phase plot of the measured S-parameter, presented in the range from -180 to +180°;
-  – S-parameter modulus (amplitude) plot on a linear scale;
-  – S-parameter modulus (amplitude) plot in logarithmic scale (in dB);
-  – voltage standing wave ratio (VSWR) plot;
-  – plot showing the distance to fault or discontinuity in the cable;
-  – plot of signal attenuation in the cable;
-  – group delay plot.

8.2.3. Function buttons

-  – expands the plot to the full screen.
-  – turn off the plot to access additional settings
-  – opens access to settings for plots and measurement modes displayed on the screen.

## 9. DEVICE MENU

### 9.1. Main menu

9.1.1. Turn on the device. There are two ways to open the main menu:

- Press the button (6) once;
- Double-tap the screen.

The main menu will be displayed on the screen, as in Figure 9.1.

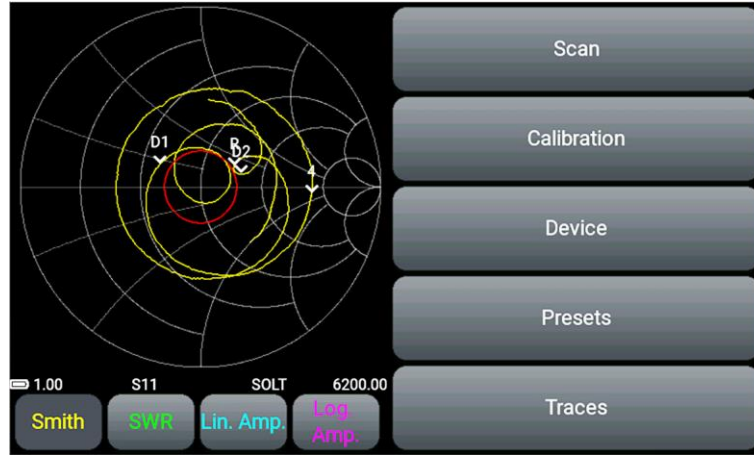

Figure 9.1 - Main menu of the device

9.1.2. Each of the sections of the main menu has its own purpose:

**Scan** – a section of the menu in which the user sets the frequency range for the test device.

**Calibration** – menu section for performing calibration.

**Device** – this section sets the electrical cable length compensation, the SWR limit line, the amplitude scale shift, and the output power level. This section contains the device's serial number and software version.

**Presets** – section for saving user settings.

**Traces** – section for saving the results of current measurements (traces) with the subsequent possibility of loading them and comparing them with the current measurement results.

9.1.3. To exit the main menu, press the button (6) once or double-tap the screen next to the plot.

### 9.2. Setting the frequency range parameters

The frequency range contains the number of parameters by which the synthesizer is rebuilt and the measurement mode is set (frequency range, number of measurement points, bandwidth of the digital IF filter).

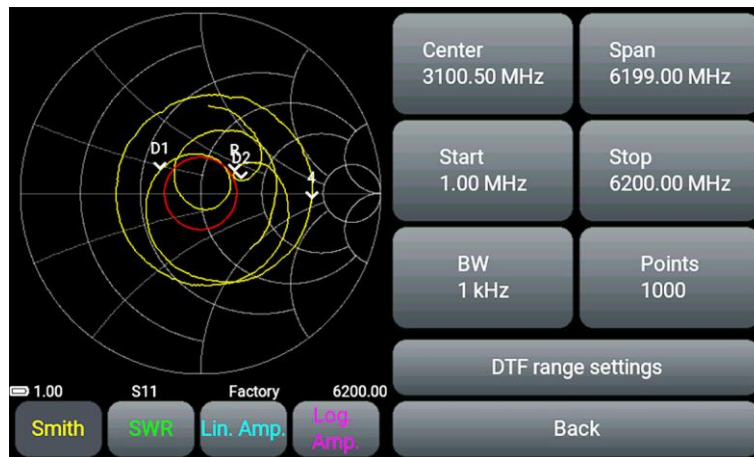

Figure 9.2 - Menu for setting scan parameters

9.2.1. Enter the **Scan** section of the main menu of the device. Menu for setting the parameters of the frequency range **Scan** is shown in Figure 9.2

9.2.2. **Scan** menu buttons:

**Center** – setting the center frequency of the scanning range.

**Span** – scanning range of frequencies.

**Start** – setting the initial frequency of the scanned frequency range.

**Stop** – setting the final frequency of the scanned frequency range.

**BW** – selection of the bandwidth of the digital IF filter.

**Points** – selecting the number of scan points.

**DTF range settings** – setting the parameters of the horizontal scale of the DTF plot. Switching to the time or distance settings of the DTF plot.

**Back** – exit to the main menu.

9.2.3. The frequency parameters **Center**, **Span**, **Start** and **Stop** are set by entering a numerical value in the opened submenu, as shown in Figure 9.3. The resolution of setting the frequency parameters is 100 Hz in the frequency range up to 100 MHz and 10 kHz in the range from 100 to 6200 MHz. Enter the numerical value of the frequencies in **MHz** or **GHz** and press the corresponding button. To delete incorrect or previously entered values, press < (**Delete**). Press × (**Cancel**) to exit the menu without entering values.

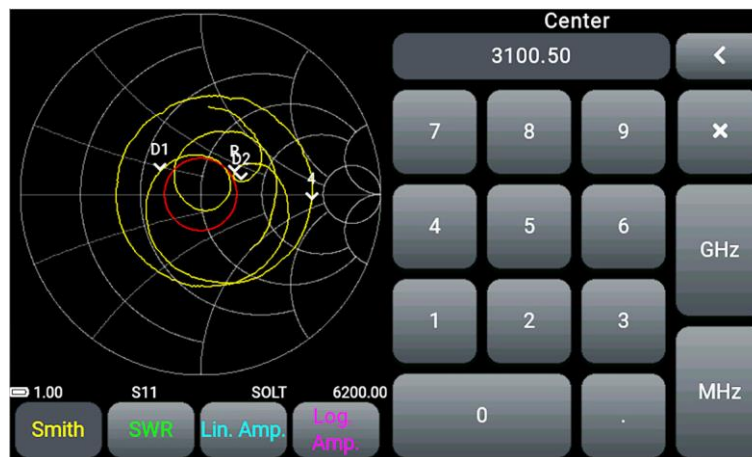

Figure 9.3 - Entering numerical values of frequency parameters

9.2.4. There are three ways to set frequency parameters:

- By entering the initial **Start** and final **Stop** frequencies, the center frequency **Center** is automatically assumed to be equal to their half-sum. The **Span** frequency range is automatically set equal to the difference between the final and initial frequencies.
- Setting the **Center** frequency and the frequency range of scanning **Span**. In this case, the **Start** and **Stop** frequencies will be set automatically as  $\text{Center} \pm \text{Span} / 2$ .
- Loading custom settings from the **Presets** menu.

If the frequency entered by the user is outside the operating range, a warning is displayed on the screen.

9.2.5. In the **BW** menu (figure 9.4), the bandwidth of the digital IF filter is selected. The narrower the bandwidth of the digital filter, the higher the signal-to-noise ratio and, consequently, the higher the measurement accuracy. As the bandwidth decreases, the scan time increases.

Reducing (narrowing) the bandwidth by 10 times will lead to an increase in the voltage signal-to-noise ratio by 3 times (or 10 dB) with an increase in scan time by 10 times.

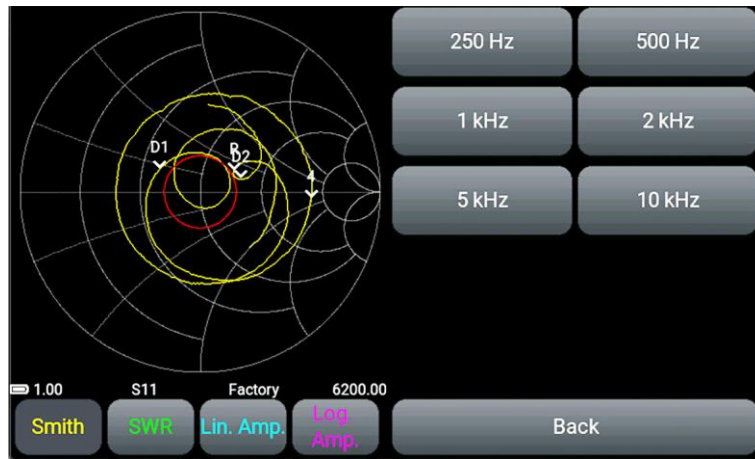

Figure 9.4 - Bandwidth selection in the BW menu

9.2.6. In the **Points** menu (figure 9.5), select the number of scan points. The frequency step and scan time depend on the set number of points. The correct selection of the number of points and the scanning range allows you to improve the resolution of measurements in the **DTF** and **Cable Loss** plots.

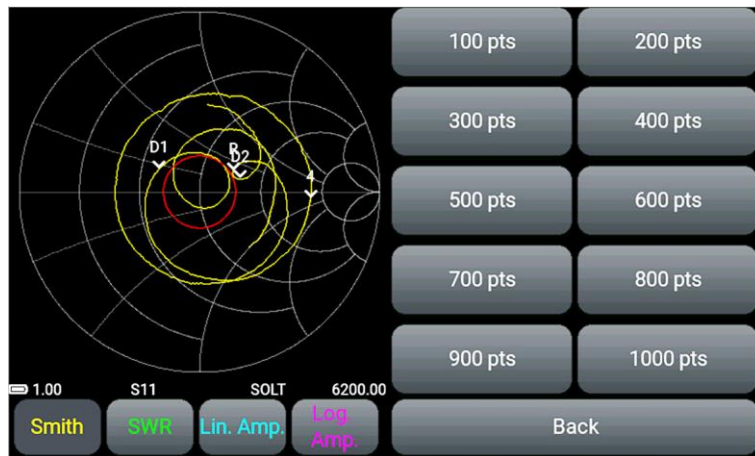

Figure 9.5 - Points, menu for selecting scan points

### 9.3. Setting parameters for measuring distance to fault

9.3.1. Enter the **Scan** section of the main menu of the device. Set the parameters of the frequency range in accordance with unit 9.2.

9.3.2. Press the button **DTF range settings**. The device menu will switch to adjust the time (Figure 9.6) or distance (Figure 9.7) parameters of the horizontal **DTF** plot scale.

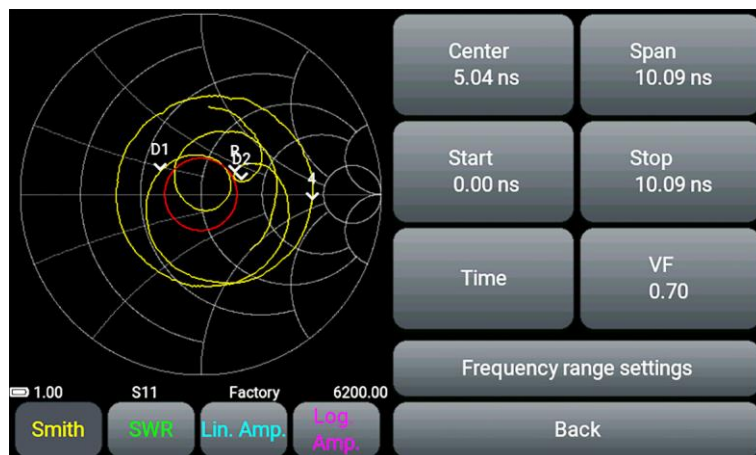

Figure 9.6 - Menu of parameters of the time scale of the DTF plot

**Center** – middle of the range displayed on the plot of time (ns).

**Span** – range of time displayed on the plot (ns).

**Start** – initial time displayed on the plot (ns)

**Stop** – the final time displayed on the plot (ns).

**Time** – switches the type of horizontal scale displayed on the plot.

**VF – Velocity factor** or the speed factor. The ratio of the speed of propagation of an electromagnetic wave in a cable to the speed of propagation of an electromagnetic wave in a vacuum. The range of values is located in the range from 0.1 to 1.

**Frequency range settings** – setting frequency parameters. Switching to frequency parameter settings.

**Back** – exit to the main menu.

Limitations of the device in displaying time

Maximum time value  $T_{MAX}$  (ns) determined by the formula:

$$T_{MAX} = \frac{(N - 1)}{(2 \times SPAN)}$$

where  $N$  – number of scan points.

$SPAN$  – scan frequency range (Hz), defined as the difference between the final and initial frequencies ( $F_{STOP} - F_{START}$ ). Wherein  $T_{MAX}$  cannot exceed the value of 9999.99 ns due to the limitation of the bit width of the display menu

- The time resolution is  $T_{MAX} / 1024$ ;
- The minimum time shown on the display is  $T_{MAX} / 8$ ;

**Attention!** In the case of setting the frequency range at which the maximum propagation time  $T_{MAX}$  exceeds the value of 9999.99 ns, the button for switching to DTF plot settings will be disabled.

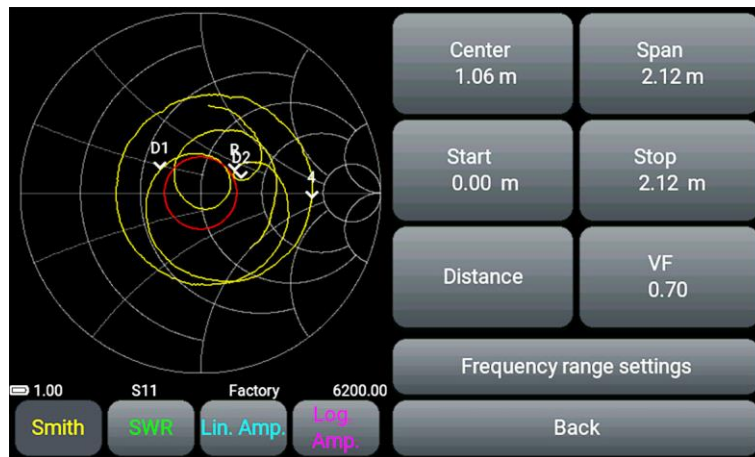

Figure 9.7 - Menu of parameters of the distance scale of the DTF plot

**Center** – middle of the range displayed on the plot of the distance (m).

**Span** – range of distance displayed on the plot (m).

**Start** – beginning of the range displayed on the plot (m)

**Stop** – finish of the range displayed on the plot (m).

**Distance** – switching the type of horizontal scale displayed on the plot.

**VF – Velocity factor** or the speed factor. The ratio of the speed of propagation of an electromagnetic wave in a cable to the speed of propagation of an electromagnetic wave in a vacuum. Values range from 0.1 to 1.

**Frequency range settings** – setting frequency parameters. Switch to frequency parameter settings.

**Back** – exit to the main menu.



Device limitations in displaying distance

- Maximum displayed distance  $D_{MAX}$  depends on the speed factor  $VF$ . When  $VF=1$ , maximum displayed distance  $D_{MAX} = 3000m$ .
- Distance resolution –  $D_{MAX} / 1024$ ;
- The minimum distance shown on the display is  $D_{MAX} / 8$ .

**For correct time or distance measurement, select a frequency range so that the maximum displayed time or length is greater than the expected cable length. Otherwise, the estimate of the time or cable length will be incorrect and certainly less than the real one.**

9.3.3. Enter the speed, time, or distance factor that determines the length of the plot's horizontal scale (figure 9.8) and click ✓ (**Data entry**). To delete incorrect or previously entered values, click < (**Delete**). To exit the menu without entering values press × (**Cancel**).

The input menu displays the maximum value that cannot be exceeded. The maximum value is limited to the selected frequency range.

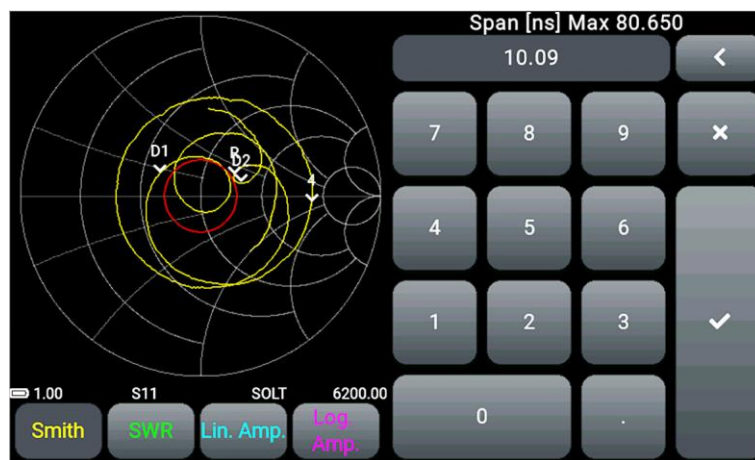



Figure 9.8 - Entering values for the horizontal scale parameters of the DTF plot

#### 9.4. Device calibration menu

**Attention!** All devices are factory calibrated by the manufacturer. Removable SMA adapters screwed onto the instrument connectors are taken as the reference plane. When using cable assemblies or additional adapters, the device must be recalibrated according to the instructions. It is recommended to use ready-made calibration kits to calibrate the device.

 **In order to avoid premature wear of the instrument connectors, it is recommended to carry out measurements with the screwed-on adapters supplied.**

**Factory** calibration information is displayed in the information bar of the screen. To increase measurement accuracy with optional adapters and cables, you must perform a full 1-port or 2-port calibration using a calibration kit, sold separately.

9.4.1. Enter the **Calibration** section of the main menu of the device (Figure 9.9).

9.4.2. To exclude the influence of connecting wires and connectors on the measurement results, carry out calibration.

Calibration is performed after warming up the device for at least five minutes. The change in ambient temperature from the moment of calibration to measurements should not exceed  $\pm 3^\circ \text{C}$ . Always calibrate the device before taking critical measurements to eliminate the influence of ambient temperature.

9.4.3. Connect the necessary accessories (connectors, adapters and cables) to the device ports **P1** and **P2** through which the device will connect to the test device. Thus, as a result of calibration, the calibration plane is transferred from the device ports **P1** and **P2** to the ends of the connected accessories.

Connect the loads from the standard set of calibration measures in series to the cable or connector connected to port **P1** (not included in the delivery package):

- Idle and press the **Open** button on the device screen;
- Short circuit and press **Short** button on the screen;
- Matched load, and press the **Load** button.

If you are performing a full two-port calibration of the device, connect the cables connected to ports **P1** and **P2** via a jumper and press the **Through** button on the screen.

After calibration, the buttons on the screen will turn green. To delete a calibration, click the **Open**, **Short**, **Load**, or **Through** button again. Connect the appropriate calibration measure and calibrate the device.

**Back** button-exit to the main menu.

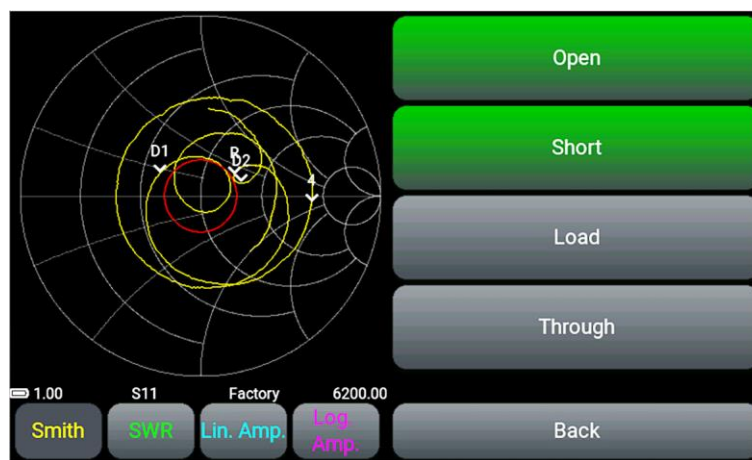

Figure 9.9 - Device calibration process

9.4.4. Calibration information will appear in the information bar on the screen:

- **Factory** – there is no custom calibration. The device is factory calibrated. Displayed on the device screen in white.
- **SOL / SOL+T** – one-port / two-port calibration performed. Calibration and frequency range are the same. In this mode, the measurement results are the most accurate. The type of calibration is displayed in white on the screen.

If during measurements the frequency range does not coincide with the range in which the calibration was performed, but the frequencies are within the calibration range, the device uses a mathematical method to calculate the calibrations based on interpolation. The measurement accuracy will be lower and the calibration type will be displayed in **blue**.

If the frequency range is outside the calibration range, the device uses a mathematical method to calculate calibrations based on extrapolation. The type of calibration will be displayed in **red** on the screen. The measurement accuracy is the lowest.



## 9.5. Information about the device

9.5.1. Enter the **Device** section of the main menu (Figure 9.10).

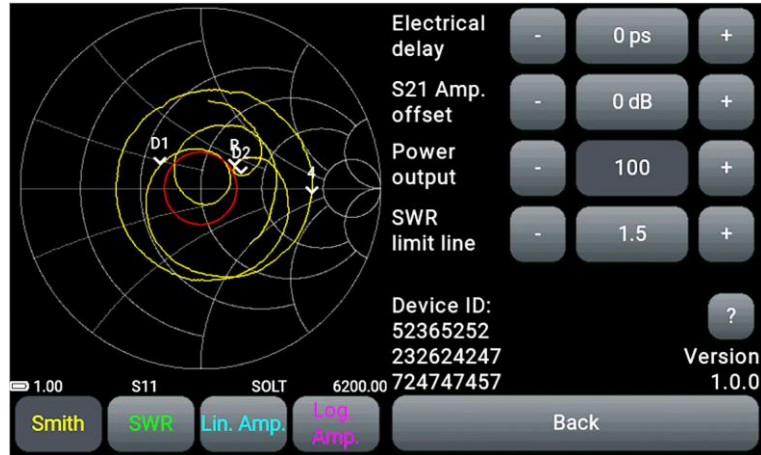

Figure 9.10 - Information about the device

Information about the device will be displayed on the screen:

- device ID;
- information about the developer;
- device firmware version.

9.5.2. In addition to information about the device, this section of the menu contains options:

- electrical cable length compensation **Electrical delay**;
- shift of the amplitude scale **S21 Amp. Offset**;
- adjusting the output signal power **Power output**;
- displaying the VSWR limit line **SWR limit line**.

For a detailed description of these options, see units 9.6, 9.7, 9.8, and 9.9.

**Back** button-exit to the main menu.

## 9.6. Compensation electrical length of the cable

9.6.1. Enter the **Device** section of the main menu (Figure 9.10).

Option **Electrical delay** designed to compensate for phase overrun and transfer of the calibration plane when connecting additional cables with low attenuation to the device.

Let's look at the example of the Smith chart, how the **Electrical delay** option of compensation for the electrical length of the cable works.

During the measurement process, when an additional adapter cable is used with a small total signal attenuation (no more than 1 dB), the calibration plane shifts. To compensate for phase overrun when additional cables are connected to the device, the measurement plane must be moved to the calibration plane.

9.6.2. Calibrate the device in accordance with unit 9.4. If the factory calibration parameters are correct for the measurement conditions, calibration is not necessary.

The graph on the Smith chart, if the calibration is successful, will be tightened into a circle with a minimum radius (Figure 9.11).

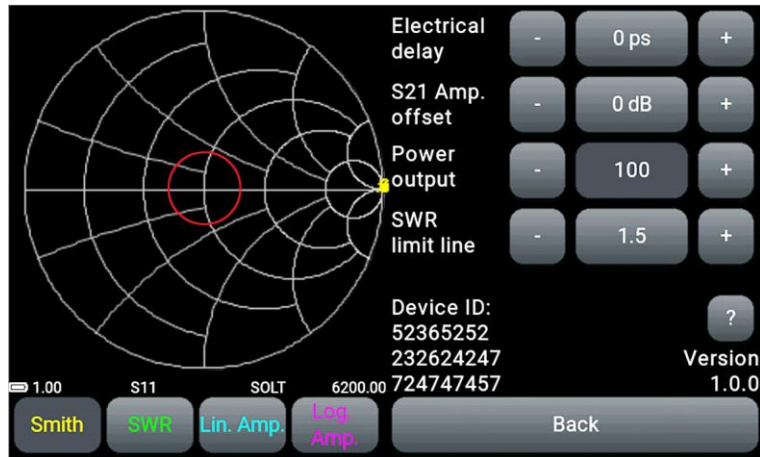

Figure 9.11 - Smith chart after calibration

9.6.3. Connect an additional (adapter) cable of short length with a total signal attenuation of no more than 1 dB. In this case, in the chart, a circle with a minimum radius is transformed into an arc (Figure 9.12).



Figure 9.12 - Offset of the calibration plane by an additional cable

This is due to the fact that the additional cable has a phase attack proportional to the length of the cable. To compensate for this phenomenon, you need to set an approximate delay value in picoseconds in the device options.

Formula for calculating the compensation of the time T of propagation of the probing signal along the additional cable:

$$T = \frac{2L}{C \times VF}$$



where L – cable length, (m)

C – the speed of light, (m / s)

VF – the velocity factor, has a value of <1

**To convert the T value into picoseconds (ps), the resulting value must be multiplied by 10<sup>12</sup>.**

9.6.4. Enter the numerical value of the compensation time (T) in picoseconds, calculated by the formula in the field **Electrical delay**.

Use the buttons  and  to adjust the exact compensation time at which the graph on the chart will be drawn into a circle with a minimum radius (Figure 9.13).

**Back** button-exit to the main menu.

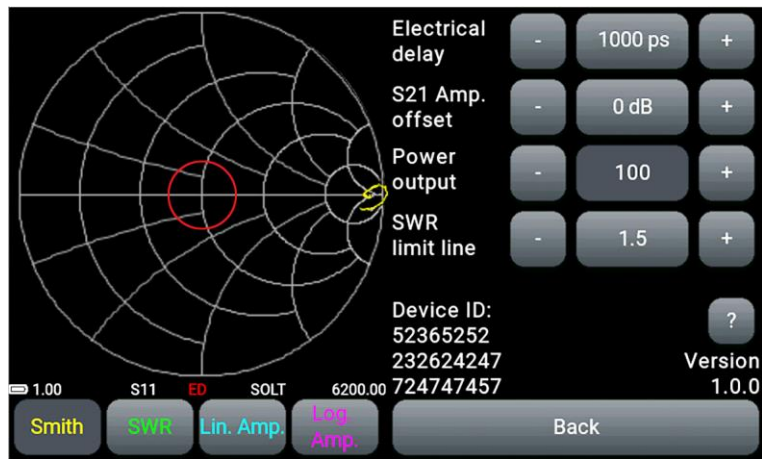

Figure 9.13 - The electrical cable length is compensated

The time compensation value is displayed on the device screen (designation ED) and is saved in the user settings Presets even when the device is turned off. When changing the calibration plane, it is necessary to delete the value of the compensation of the electrical length of the cable, setting the value equal to zero.

### 9.7. Shift of the amplitude scale on plots Lin. Amp and Log. Amp

It is used for convenience when measuring the amplitude-frequency characteristic (AFC) of active devices.

**⚠ The maximum allowable input power is +10 dBm. It is recommended to use external attenuators when measuring the parameters of active devices, which reduce the input signal power to a level of no more than 0 dBm.**

9.7.1. Install external attenuators in the test port circuit of the device.

9.7.2. Enter the **Device** section of the main menu (Figure 9.10).

9.7.3. When using external attenuators or amplifiers, to correctly display the amplitude of the input signal, enter the scaling value **S21 Amp. offset** in decibels via the numerical value input menu or buttons



For the convenience of displaying a real plot on the grid of the device, the numerical value of the attenuation can be entered either positive or negative.

The device will automatically shift the plot within the measurement range, compensating for signal attenuation by external attenuators (Figure 9.14).





Figure 9.14 - Compensation of signal attenuation by attenuators

The value of the **S21 Amp. offset** scale shift is displayed in red on the screen and saved in the user **Presets** settings and when the device is turned off. If you disable external attenuators, you must remove the scale offset value by setting the **S21 Amp. offset** value to zero.

### 9.8. Adjusting the output power of the probe signal generator

9.8.1. Enter the **Device** section of the main menu (Figure 9.10).

Adjusting the output power level of the probe signal generator **Power output** expands the measurement capabilities of active devices and reduces the likelihood of exceeding the maximum input signal power of the **P2** port of the device.

Use the buttons  and  to adjust the power output level of the probe signal generator.

### 9.9. Displaying the SWR limit line

For ease of use, you can set the limit line of the voltage standing wave ratio (VSWR). The line will be displayed in red on **Smith**, **Polar**, **SWR** and **Log. Amp** (in measurement mode S11).

9.9.1. Enter the **Device** section of the main menu (Figure 9.10).

9.9.2. The SWR line display is switched off and on by pressing the button with the numerical value of the coefficient (Figure 9.15).

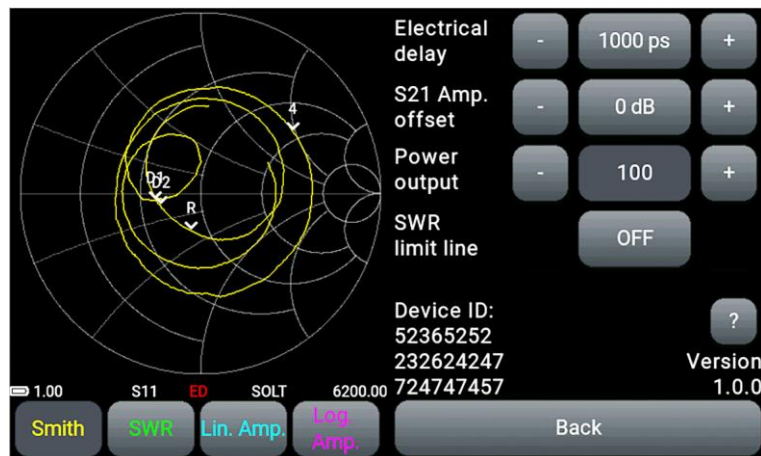



Figure 9.15 - Displaying the VSWR limit line is off



9.9.3. Use the buttons  and  to change the value of the **SWR limit line** in the range from 1.1 to 9.9.



### 9.10. Configuring plot parameters

9.10.1. Exit the main menu of the device by pressing the button (6) once. Select the plot and click **Controls**. The plot management menu appears on the screen, as shown in Figure 9.16.



Figure 9.16 - Menu for setting the plots displayed on the screen

9.10.2. Use the buttons  and  to narrow and expand the range of frequencies displayed on the screen.

9.10.3. Move the plot to the left-right by using the buttons  and .

9.10.4. Change the type of the displayed plot by clicking the button with the name of the active plot and choosing a new one from the list (Figure 9.17). **Back** button - exit from the list of plots.







Figure 9.17 - Selecting a plot from the list

If you set the frequency range, where the maximum propagation time exceeds 9999.99 ns, the **DTF** plot button will be disabled. More detailed information is in unit 9.3 of this «Manual».

9.10.5. To configure the plot display, click **Settings**. The menu appears on the screen as shown in Figure 9.18.



Figure 9.18 - Plot display settings

The buttons  and  change the scale of the vertical axis. The reference level of the plot is moved with the buttons  and .

Sequential switching of the data source is done with the **S11** button. The dynamic data **S11** and **S21** are real-time measurement plots. Static data **Trace S11** and **Trace S21** - saved and loaded by the user measurement results (traces). The process of saving and loading measurement results is described in detail in unit 9.13.

The **Exclusive / Layer** button switches the plot display type. In **Exclusive** mode, only the active plot is displayed. In the **Layer** mode, inactive plots are displayed in a semi-transparent background under the active plot.

Switching the phase plot and the unwrapped phase plot with the **Normal / Unwrapped** button.

**Back** button - exit from the list of plots.

### 9.11. Marker measurements

On plots, in addition to the **DTF** plot, up to four markers can be set to display numerical measurement results. Markers are completely independent from each other and can be adjusted according to the type of values displayed by the marker and by frequency.

9.11.1. Select a plot. To the right of the plot there are four marked fields for displaying markers. After clicking on one of the fields, a menu will appear, as in Figure 9.19.



Figure 9.19 - Setting the marker



9.11.2. Turning on, off and setting the type of the marker is performed by the marker status button:

**Off** – marker off;

**Point** – the marker is set at a point on the plot at a frequency specified by the user;

**Delta** – marker for measuring increments relative to the reference marker.

When multiple delta-markers are set, the first delta-marker automatically becomes the reference marker.

On the plot, the delta-markers are displayed with the letter D, the reference marker with the letter R.

It is also possible to set a marker when you touch the screen in the area of interest of the plot with a duration of about two seconds. If there are no markers set on the chart, then as a result of a long touch, marker 1 will appear. When repeating, the next marker in a row.

9.11.3. Configure the type of values displayed by the marker by pressing the button with the type of displayed value, select the type from the list (Figure 9.20). **Back** button - exit from the list.



Figure 9.20 - Selecting the type of value displayed by the marker

Table 3 - Values displayed by markers

<b>Auto</b>	The values are displayed in the interpretation corresponding to the displayed plot. Switching the plot automatically changes the type of interpretation.
<b>Re, Im</b>	Displaying the amplitude of the real and imaginary parts of the complex reflection coefficient.
<b>LMag, Phase</b>	Displaying magnitude in decibels and phase in degrees
<b>SWR</b>	The standing wave ratio (VSWR).
<b>Z=R+jX</b>	Displays the active and reactive parts of the impedance in ohm. Type of reactivity-capacitance or inductance.
<b>Y=G+jB</b>	Displays the active and reactive parts of the admittance in millisiemens (mS). Type of reactivity-capacitance or inductance.

9.11.4. Enter the frequency at which the marker will be set.

There are several ways to enter and change the frequency at which the marker is located:

- By pressing the button with the frequency display and further transition to the menu for entering numerical values.



- By pressing the navigation buttons and .
- Moving the marker on the screen using a grip with your finger or stylus.

Moving the marker and changing the frequency will occur with a Step equal to:

$$Step = \frac{SPAN}{(N - 1)}$$

where *Step* – marker movement step  
*SPAN* – scanning frequency range  
*N* – number of scan points.

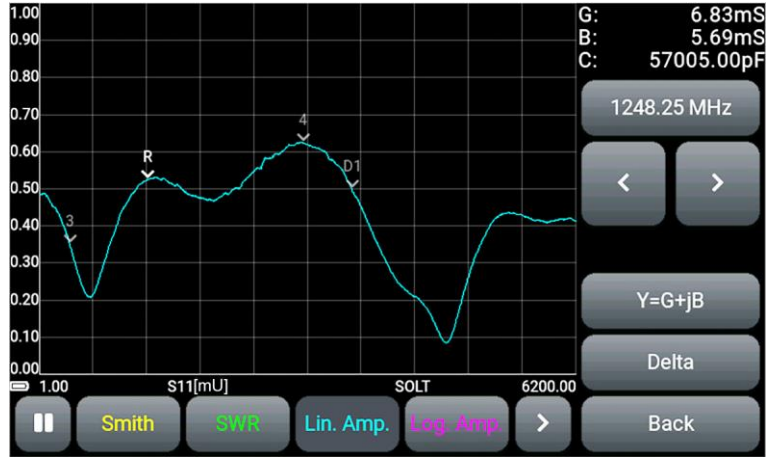

Figure 9.21 - Setting the marker at a given frequency

9.11.5. To change the display parameters of the selected marker, click to the right of the plot on one of the four blocks with marker parameters. Below, in Table 4, the types of parameters displayed by markers in blocks are indicated.

Table 4 - Value of parameters displayed by markers

Re: Im:	<b>Amplitude of complex RC and TK</b>	R: X: C:	<b>Impedance</b>
Mg: Ph:	<b>Magnitude and Phase</b>	G: B: C:	<b>Admittance</b>
SWR:	<b>VSWR</b>		

9.11.6. For the **DTF** plot, turning on, off and setting the marker is performed by the marker state button:

**Off** – marker off;

**Point** – the marker is set at a point on the plot at a user-specified distance or time from the start of the countdown;

**Peak (maximum)** – the marker will be set at the maximum point of the plot automatically. In this case, the previously entered time or distance value is ignored.

9.11.7. For a marker in the **Point** state, set the time (ns) or distance (m) from the reference point on the plot for taking measurements.

Parameters of **Point** markers (time or distance) depend on the selected units of measurement in the menu for setting the frequency scale parameters for the **DTF** plot (see unit 9.3).







Figure 9.22 - Setting parameters of DTF plot markers

Entering and changing the time (ns) or distance (m) from the reference point, at which the marker is located, is carried out in several ways:

- By pressing the button with display of time or distance and further transition to the menu for entering numerical values.



- By pressing the navigation buttons  and .
- By moving the marker on the device screen.

Moving by buttons is possible only for markers of the Point type. Peak markers do not move.

## 9.12. User settings menu

9.12.1. Enter the **Presets** section of the main menu (Figure 9.23).

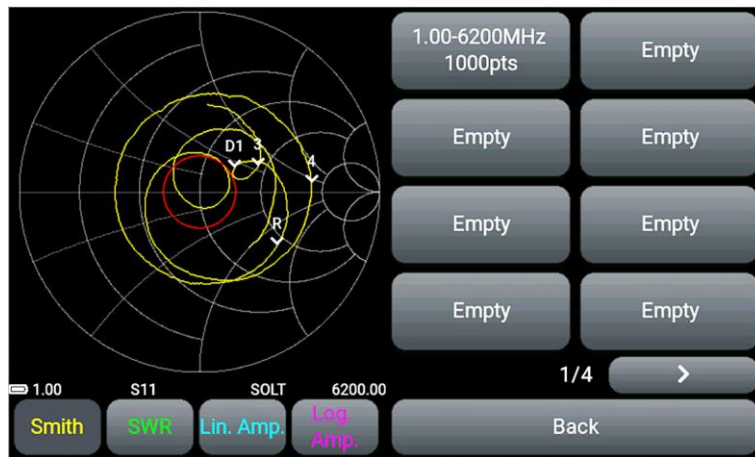

Figure 9.23 - User settings menu

9.12.2. The device stores in memory 32 user settings on four pages. Click the **Empty** button to save the settings. If all buttons are occupied with user settings, rewrite by clicking on the button with outdated or unnecessary settings. Click the **Save preset** button to save the setting. A new button appears with the default setting label.

Saving a custom setting takes about 2 seconds. At this time, the device does not respond to touching the screen and pressing a button.

9.12.3. By clicking on the button with the saved setting, the user can apply the **Apply preset** setting or delete the **Erase preset** setting (Figure 9.24).

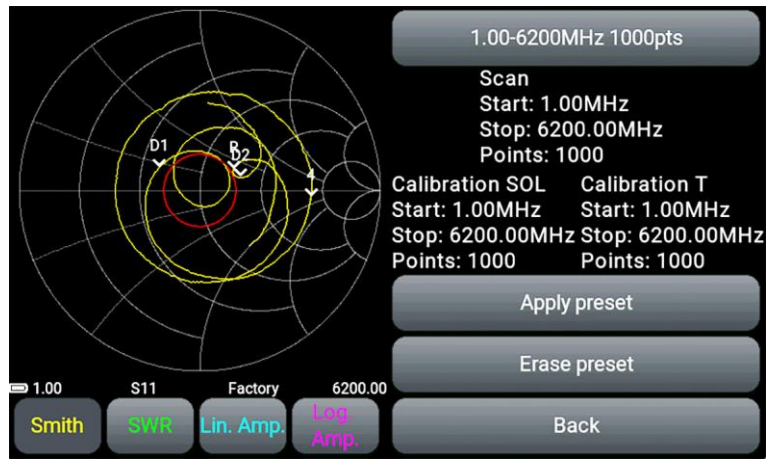

Figure 9.24 - Menu for working with custom settings

9.12.3. The user can rename the saved settings. To do this, click the button with the name of the selected setting. Change the name of the setting using the on-screen keyboard (Figure 9.25).



Figure 9.25 - Changing the name of the custom setting

To save the setting with the default name, leave the field empty.

### 9.13. Saving measurement results

The device has the ability to save the measurement results-traces, with the possibility of subsequent viewing and comparison with the results of current measurements.

9.13.1. Enter the **Traces** section of the main menu of the device (Figure 9.26).

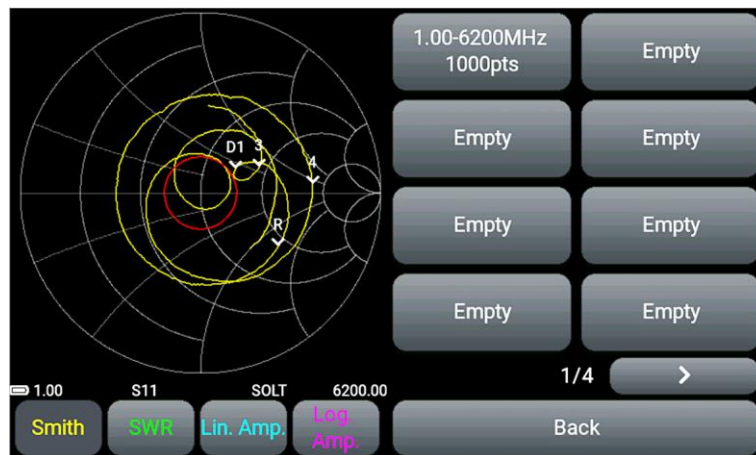

Figure 9.26 - Menu for saving measurement results

9.13.2. The device stores 32 measurement results (traces) in memory. Press the **Empty** button to save the measurement results. If all buttons are occupied with measurement results, rewrite by pressing the button with outdated or unnecessary results. Click the **Save trace** button to save the result. A new button appears with a standard label.

9.13.3. By clicking on the button with the saved trace, the user can load the **Load trace** or delete the **Erase trace** (Figure 9.27).

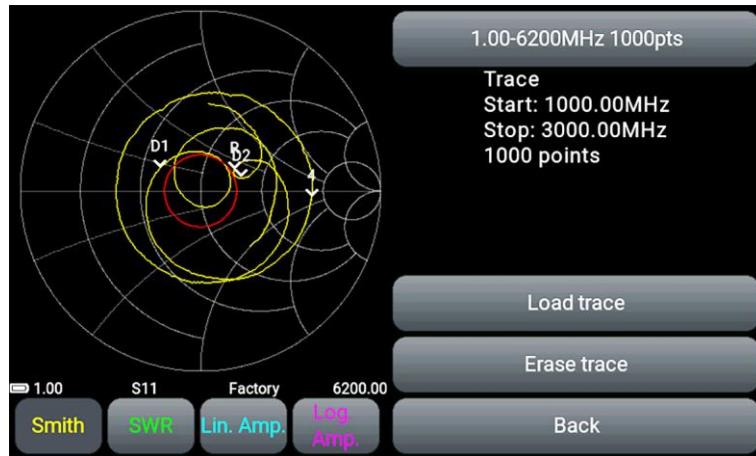

Figure 9.27 - Menu for working with saved traces

Turning on, viewing and comparison of the loaded trace with the results of current measurements is carried out in several ways:

- Sequential switching of real plots and saved traces using the data source button **S11 – Trace S11 – S21 – Trace S21** (see unit 9.10).
- Setting up plots of the same type with different data sources (real plot and saved trace) in the **Layer** view (Figure 9.28).



Figure 9.28 - Comparison of the saved trace with the real plot

9.13.4. Disabling of the measurement results viewing mode is performed by the **Unload trace** button in the **Traces** menu (Figure 9.29). The plots in the mode of viewing the saved results of **Trace S11** or **Trace S21** will automatically switch to displaying the current measurements of **S11** or **S21**.

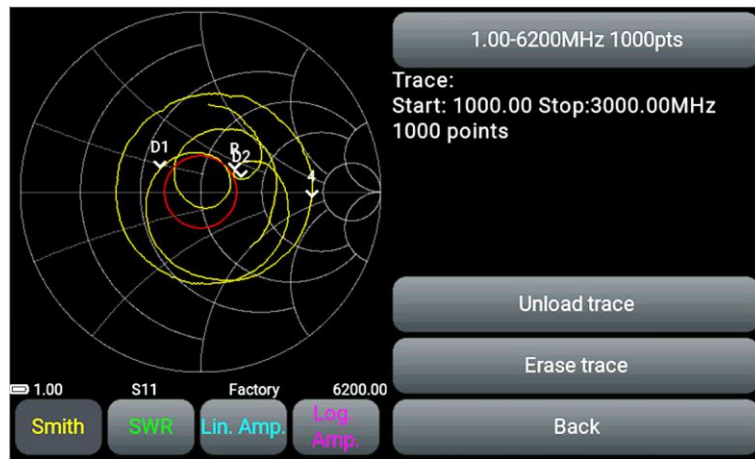

Figure 9.29 - Disable viewing of saved measurement results

9.13.5. The user can rename the saved measurement results. The process is the same as for renaming user settings in unit 9.12.3.

## 10. CHARTS AND PLOTS

### 10.1. Smith chart

10.1.1. The Smith chart (impedance pie chart) is intended to determine the complex resistances of the tested load and allows the complex reflection coefficient to be displayed graphically on a plane. The horizontal axis is the real part of the reflection coefficient (RC), and the vertical axis is the imaginary part of the RC. The center of the chart corresponds to an impedance of 50 Ohm.

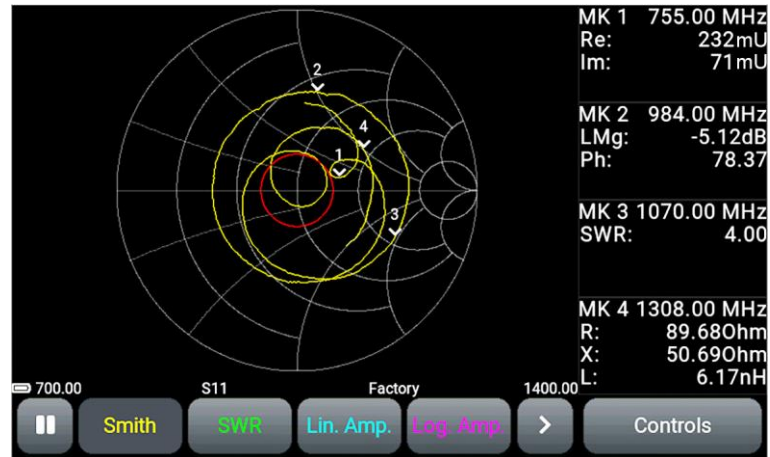

Figure 10.1 - On the screen the Smith chart

10.1.2. Additionally, in the **Device** menu, the display of the SWR limit line with the setting of a numerical value can be enabled (see unit 9.9.). The Smith chart allows you to evaluate the circuit mismatch and the nature of the load: purely active, reactive-inductive, reactive-capacitive or complex.

### 10.2. Polar chart

10.2.1. The polar chart is designed to display the complex reflection coefficient in a two-dimensional coordinate system (Figure 10.2). The chart is similar to the Smith chart, but its scale grid is reduced to certain values of VSWR - 2; 5.

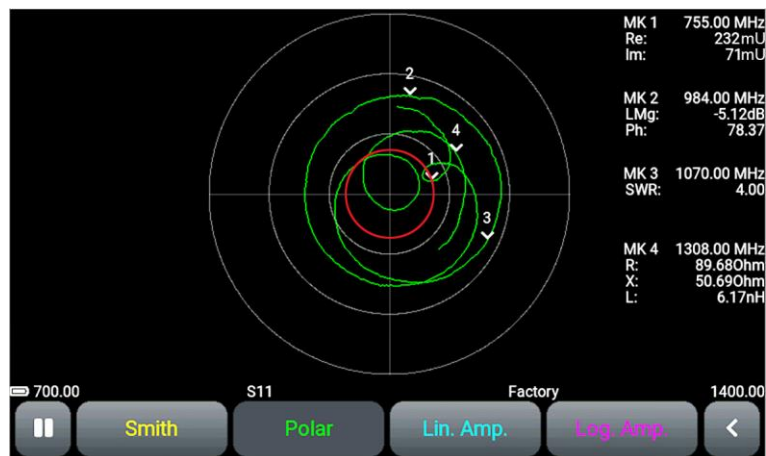

Figure 10.2 - Polar chart

10.2.2. Additionally, in the **Device** menu, the display of the SWR limit line with the setting of a numerical value can be turned on (see unit 9.9.). The red circle around the center of the chart corresponds to the specified SWR value. If the chart does not go beyond the SWR limit line, then the SWR of the measured load does not exceed this value.

### 10.3. Phase plot

10.3.1. The plot shows the dependence of the S-parameter on frequency. The measurement range is from minus 180 to plus 180 degrees (Figures 10.3 - 10.6).

The plot can be represented as an unfolded phase plot. In this case, the measurement range is below minus 180 and above plus 180 degrees (Figures 10.4 and 10.6).

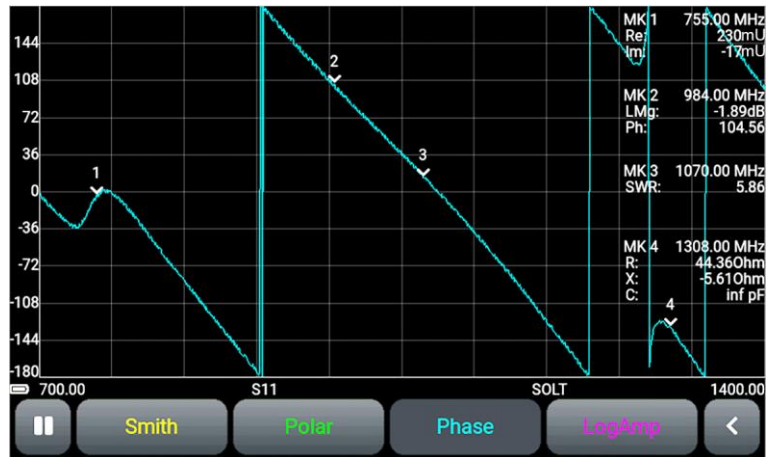

Figure 10.3 - Phase plot in measurement mode S11



Figure 10.4 - Plot of the unwrapped phase in S11 measurement mode

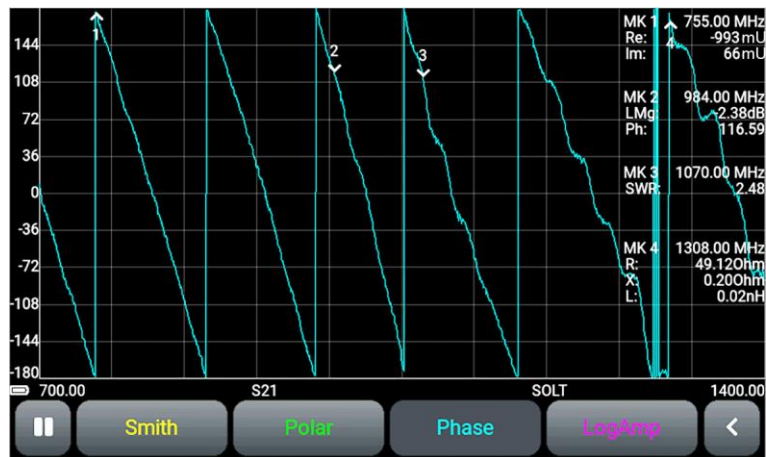

Figure 10.5 - Phase plot in measurement mode S21





Figure 10.6 - Plot of the unwrapped phase in the S21 measurement mode

#### 10.4. Plot of the magnitude (modulus) of the reflection coefficient on a linear scale

10.4.1. The plot shows the dependence of the RC and TC magnitudes on the frequency on a linear scale (figure 10.7). Vertical scale of the plot in units (dimensionless value).

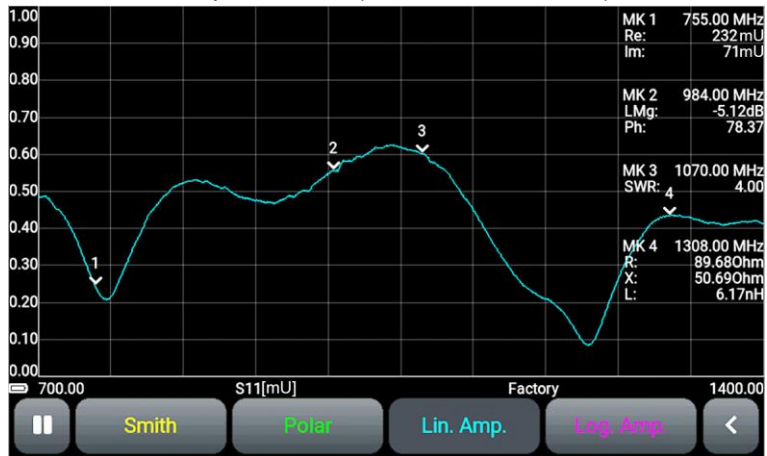

Figure 10.7 - Linear plot of the magnitude (mode S11)

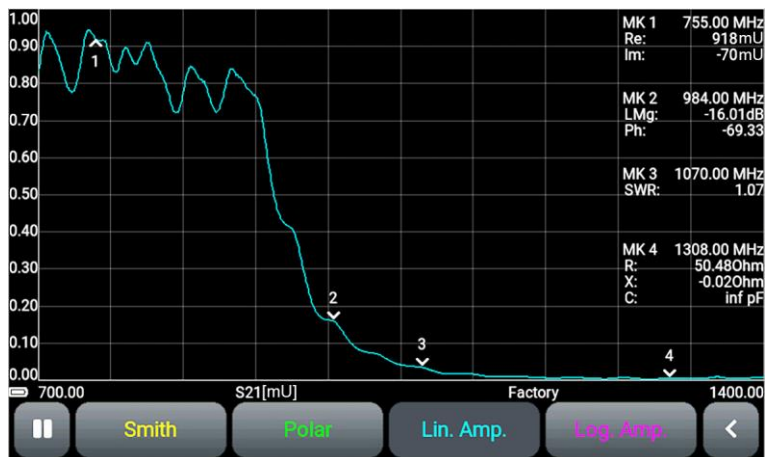

Figure 10.8 - Linear plot of the magnitude (mode S21)

#### 10.5. Plot of the magnitude (modulus) of the reflection coefficient on a logarithmic scale

10.5.1. The plot shows the dependence of the magnitude of the RC and TC on the frequency in logarithmic scale, in dB (Figure 10.9.). Vertical scale of the plot is displayed in dB

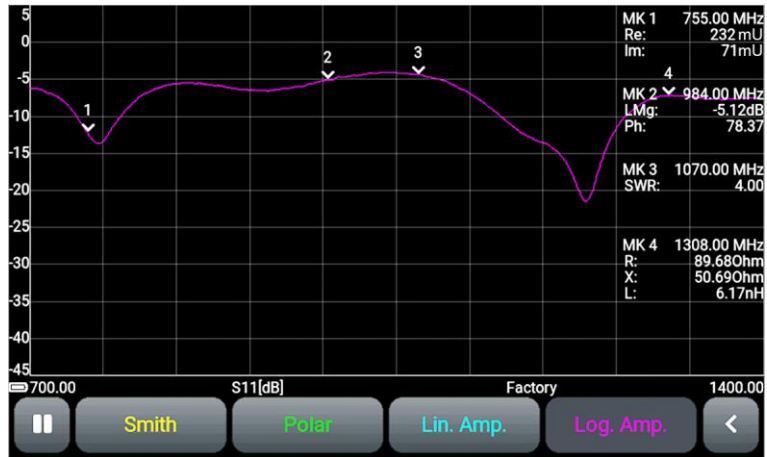

Figure 10.9 - Logarithmic plot of the magnitude (mode S11)

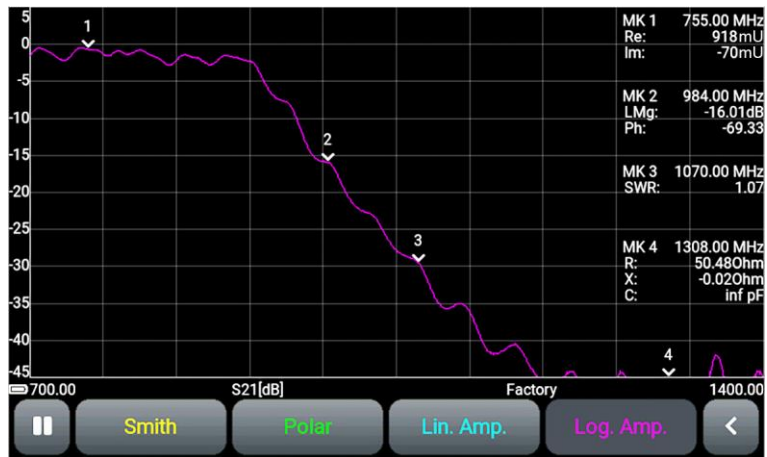

Figure 10.10 - Logarithmic plot of the magnitude (mode S21)

## 10.6. VSWR plot

10.6.1. The plot shows the voltage standing wave ratio (VSWR), (Figure 10.11).

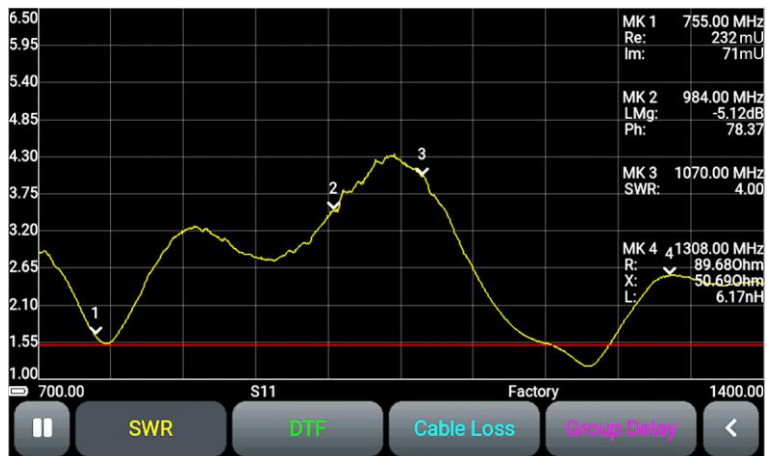

Figure 10.11-VSWR plot

## 10.7. Measuring the distance to fault

10.7.1. **DTF – distance to fault** – distance to damage. This plot (Figure 10.12) allows you to measure the distance to fault or heterogeneity of the cable in the communication lines. Calculated as the inverse Fourier transform of the frequency array of reflection coefficients.



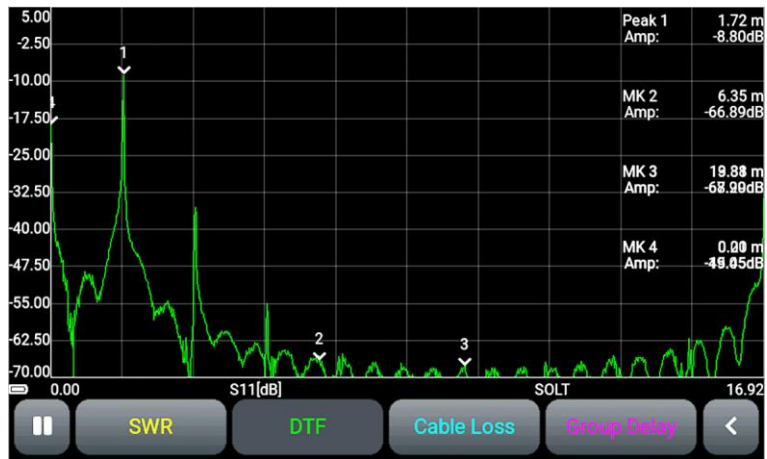

Figure 10.12 - Plot of distance measurement to cable fault

## 10.8. Cable loss plot

10.8.1. Cable insertion loss depends on the signal frequency. The higher the frequency, the greater the loss. Typically, cable manufacturers report their cable losses at one or more frequencies. To determine the loss in a different frequency range or when using a cable of which the loss is unknown, use the cable loss determination plot (Figure 10.13).



Figure 10.13 - Plot of cable loss measurements

10.8.2. To take measurements, you must configure the device as follows:

In the **Controls** plot management menu, set the units of measurement and cable length in the **Settings** menu (see unit 9.10).

- If cable length is not important, select the unit of measure decibel (dB).
- If the cable length is known (measured using the DTF plot), to display the loss, set the loss unit in decibels per linear meter (dB / m) and enter the cable length (Figure 10.14). The range of values of the measured cable length is 1-1000 m.

When displaying measurement results, the scale of the plot is selected by the device automatically.



Figure 10.14 - Selecting units and entering cable length

To obtain correct measurement results, it is necessary to choose a scanning step several times less than the period of phase oscillations. The period of the oscillations is equal to the ratio of the propagation speed to twice the value of the cable length.

$$\frac{SPAN}{N - 1} < \frac{C \times VF}{2 \times L}$$

where *SPAN* – scanning frequency range (Hz), defined as the difference between the final and initial frequencies ( $F_{STOP} - F_{START}$ )

*N* – quantity of scan points

*C* – speed of light, m / s

*VF* – speed factor

*L* – cable length, m

### 10.9. Group delay plot

10.9. The group delay is the propagation time of the signal through the analyzed circuit. This signal delay will differ for different frequencies if the test device does not have a linear phase response (PFC). To determine the group delay of the signal phase in a certain frequency range, a plot is used (figure 10.15). By measuring the phase of parameter S21, the analyzer calculates the group delay of the test device. The resulting values are displayed in nanoseconds (ns).

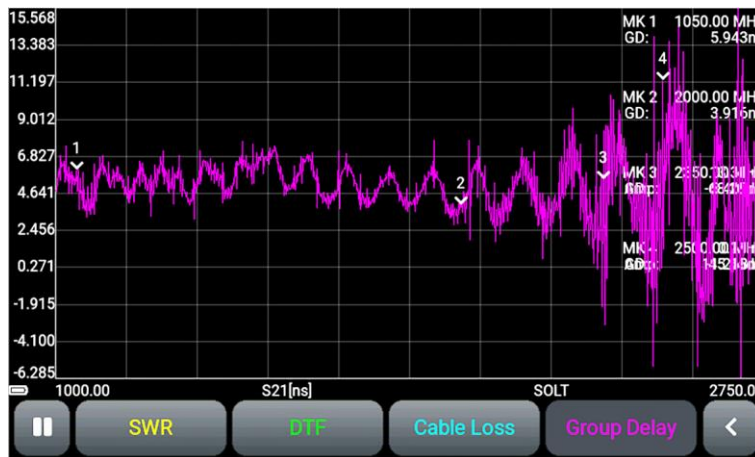

Figure 10.15 - Group delay plot

The measurement procedure is associated with the determination of the group delay  $T_{GR}$  in the form of a negative derivative of the phase  $\varphi$  (in degrees) on the frequency  $f$ :

$$T_{GR} = -\frac{1}{360^\circ} \times \frac{\Delta\varphi}{\Delta f}$$

where  $T_{GR}$  – group delay,

$\Delta\varphi$  – phase increment in degrees, defined as the phase difference  $\varphi_2$  and  $\varphi_1$

$\Delta f$  – frequency increment in hertz, defined as the difference between  $f_2$  and  $f_1$ .

## 11. CARE AND MAINTENANCE

### 11.1. General care of the device

11.1.1. Technical service consists in keeping the device in working condition, regular carrying out preventive work.

11.1.2. The connectors of the test ports are wiped with a soft cloth or a brush dipped in rectified ethyl alcohol, preventing alcohol from getting on the surfaces of dielectrics.

11.1.3. The case of the device is cleaned from contamination with a soft cloth moistened with soapy water or wet household wipes. The penetration of liquids into the device case is not allowed!

 **Do not use alcohol-based or petroleum-based solvents to clean the screen and the device case! These liquids can damage the outer coating of the screen and the product case.**

### 11.2. Battery charging

11.2.1. To charge the battery, we recommend using a stable power supply with an output voltage of 5V and a current of at least 1000 mA.

The device has an intelligent system for determining the maximum charging current depending on the available power source. When the charger is connected, the maximum charging current is automatically detected. To reduce the charging time of the built-in battery, it is recommended to use industrial power supplies (chargers) with a maximum output current of 3 A.

11.2.2. Connect the USB cable supplied with the Mini-USB connector of the device (9) with the USB connector of the power supply or the USB port of the PC.

11.2.3. The **CHARGE** indicator (8) informs you about the battery charging process. The battery charging process will take about 3.5 hours. When charging is complete, the **CHARGE** indicator (8) turns off.

The device is allowed to operate while the battery is charging, provided that the power supply is capable of providing an output current of at least 1500 mA. If the charger or USB port of the PC is not able to provide the required current for the device to operate and charge the battery, the device will automatically lower the current consumption until the battery is completely stopped.

### 11.3. Battery replacement

11.3.1. After a certain period of time, the capacity of the Li-Ion battery decreases, and long-term use of the device without recharging becomes difficult.

11.3.2. Battery replacement is necessary if:

- the battery charges very quickly and discharges very quickly;
- the battery takes a very long time to charge (more than 10 hours);
- the battery does not take charge;
- the device does not turn on in offline mode (with the charger cord disconnected).

11.3.3. To replace it, you need to purchase a new Li-Ion battery with an operating voltage of 3.7 V, a capacity of at least 5000 mAh and dimensions of no more than: height 7 mm, length 90 mm, width 60 mm.

When purchasing and installing a battery with a capacity that is different from the capacity of the device installed by the manufacturer, you should take into account the fact that the time to fully charge the battery will also change up or down.

 **When using a battery of a different capacity, the correspondence of the displayed battery charge level on the device screen to the real value is not guaranteed.**

 **To replace the battery, you will need to disassemble the device. Make sure you have the tool, knowledge, and qualifications to replace the battery yourself. If you do not have enough experience and qualifications, contact specialists with the appropriate qualifications.**

11.3.4. Remove the 4 screws (10) on the high-frequency connector panel (3). Then remove the 2 upper screws (10) on the display panel (5). (Figure 11.1).

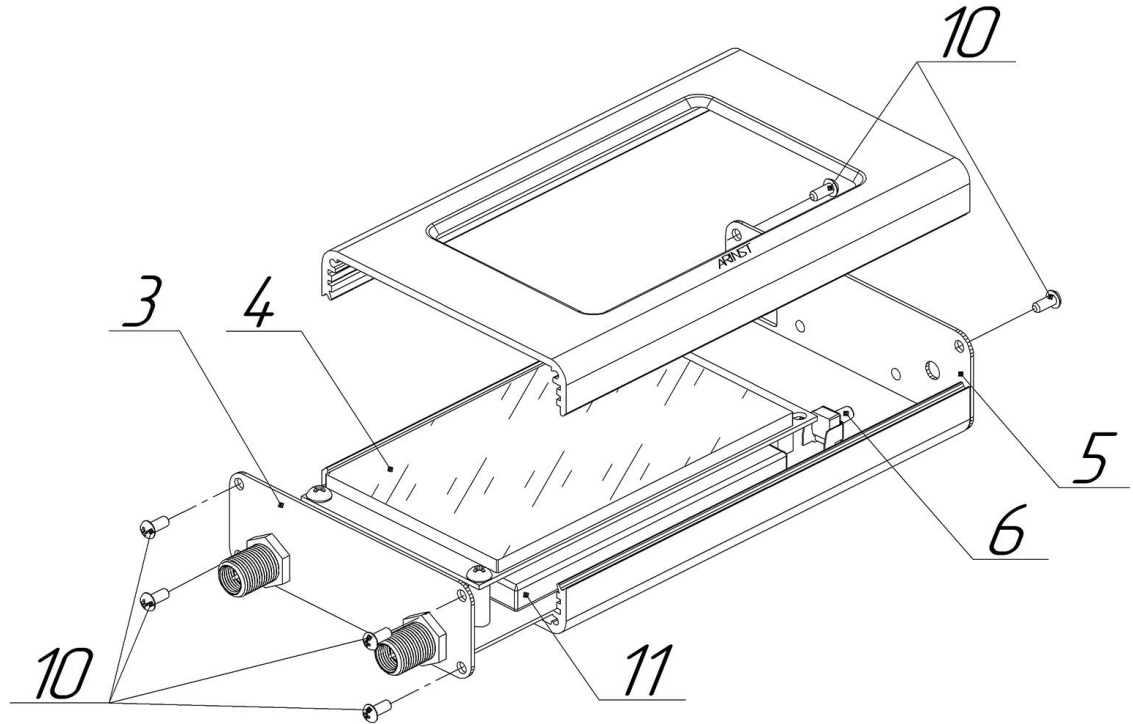

Figure 11.1 - Disassembly of the device case

11.3.5. Carefully remove the upper case. Slide along the guide grooves in the lower part of the case chassis assembly with a printed circuit board and a screen module (4).

11.3.6. The battery (11) is located on the board under the screen module (4) and secured with double-sided tape. Carefully disconnect the battery connector (12) (11) from the PCB connector (figure 11.2). Remove the old battery (11) and remove the old double-sided tape that was used to attach it to the board.

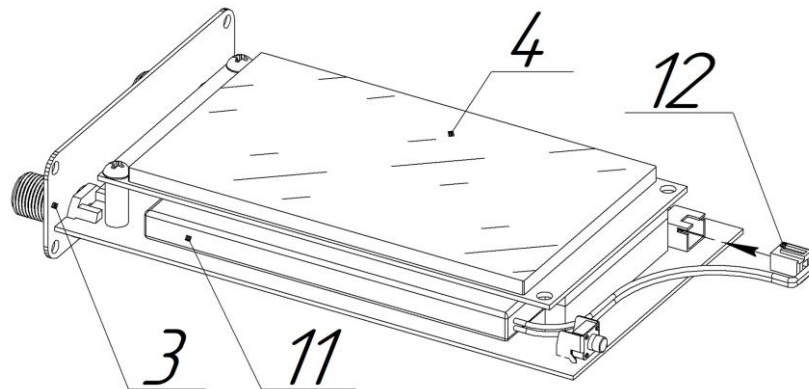

Figure 11.2 - Replacing the battery

11.3.7. Apply double-sided tape and glue the new battery (11) securely to the board. Connect the battery connector (12) to the connector on the board. Assemble the device case in reverse order.

11.3.8. After assembling the device, charge the battery in accordance with unit 11.2.

#### **11.4. Keeping**

11.4.1. Before commissioning, the device must be stored in the manufacturer's packag at an ambient temperature of 0 to plus 40 ° C and a relative humidity of no more than 80% (at a temperature of plus 25 ° C).

11.4.2. Store the device without packag at an ambient temperature of 0 to + 35°C and a relative humidity of no more than 80% (at a temperature of + 25°C).

#### **11.5. Transportation**

11.5.1. It is allowed to transport the device in a shipping container by all means of transport at an ambient temperature from minus 40 to plus 60°C. During transportation, the device must be securely fastened. Shaking, knocking and dropping can damage the device.

11.5.2. When transported by air, the device must be placed in a heated, sealed compartment.

11.5.3. During transportation, the device must be protected from atmospheric precipitation and dust.

#### **11.6. Limit state criterion**

11.6.1. The criterion for the limit state of the device is a feature, or a set of features, when which:

- further operation of the device is not allowed;
- restoration to a working condition is impossible or economically impractical.

11.6.2. Upon reaching the limit state, the device must be removed from service and disposed of.

#### **11.7. Utilization**

Check out the local system for separate collection of electrical and electronic goods. Follow local regulations. Dispose of the equipment separately from household waste. Proper disposal of your device will prevent possible negative consequences for the environment and human health.

## 12. POSSIBLE MALFUNCTIONS AND METHODS OF THEIR ELIMINATION

If there is a malfunction in the device, check the possible causes of the malfunction in Table 5.

Table 5

<b>Malfunction manifestation</b>	<b>Possible reason</b>	<b>Methods of elimination</b>
1. The device does not turn on.	Battery discharged.	Charge the battery.
	Multifunctional button <b>MENU</b> defective.	Contact the service center for repair.
2. The device does not turn on in autonomous mode.	Battery defective	Replace battery.
3. The battery life is less than 1 hour.	The device is operated at extremely low ambient temperatures.	Operate the device at an ambient temperature from 0 to plus 40 ° C.
	Battery discharged.	Charge the battery..
	Battery defective	Replace battery.
4. The device screen does not respond to touch or responds with a delay.	The device is operated at extremely low ambient temperatures.	Operate the device at an ambient temperature from 0 to plus 40 ° C
	Dirty screen.	Clear the screen.
	Lost the factory calibration of the screen	Calibrate the device screen according to unit 13.
	The display module of the device is faulty.	Contact the service center for repair.
5. The test device is connected to the ports P1 and P2, and there is no signal display on the plot.	Wrong measurement mode selected or wrong frequency range set.	Set the correct measurement mode or set the correct frequency range.
	There is no contact between the equipment cable and ports <b>P1</b> and <b>P2</b> of the device.	Make sure that the cables of the test equipment are securely connected to the device connectors.
	The input circuit of the device is defective.	Contact the service center for repair.
6. Poor measurement accuracy.	The input circuit of the device is faulty due to exceeding the maximum voltage on port <b>P1</b> and / or <b>P2</b> .	Contact the service center for repair.

### 13. RETURN THE DEVICE TO FACTORY SETTINGS

13.1. Turn on the device. While the device is loading, tap and hold the graph image on the screen for a few seconds (Figure 13.1).

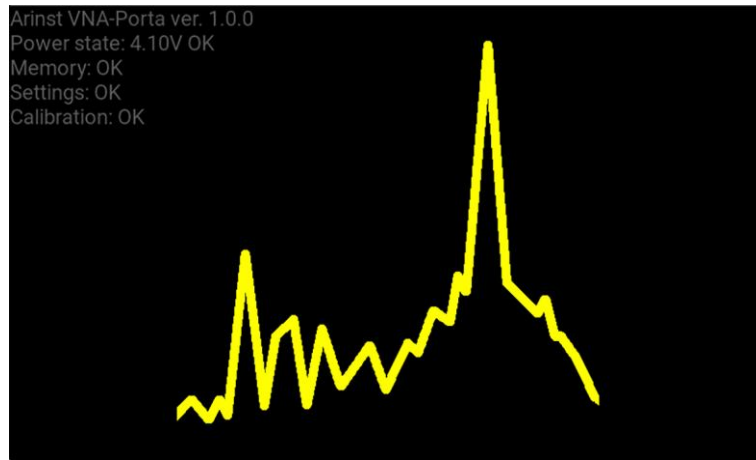

Figure 13.1 - Loading the device after turning on

13.2. The reset menu will appear on the device screen (Figure 13.2).

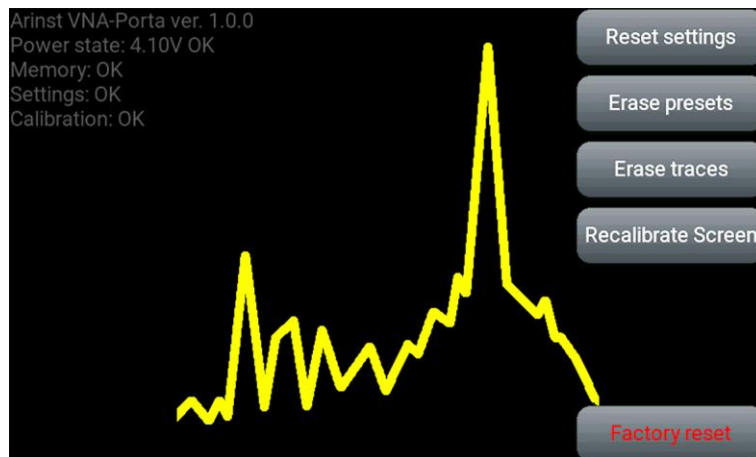

Figure 13.2 - Menu of device settings reset

Touch and hold the command button for about 2 seconds:

**Reset settings.** Resets selected plots, current measurement frequency range and device calibrations. Only the **Factory** calibration remains in the device.

**Erase presets.** Removing custom settings from the **Presets** section of the main menu.

**Erase traces.** Removing the saved measurement results from the **Traces** section of the main menu.

**Recalibrate Screen.** Calibration of the device screen. Executed in cases where the screen takes too long or does not respond correctly to pressing. Make sure the screen is clean before calibrating. Follow the instructions in the screen calibration utility.

Custom screen calibrations are applied after the device is loaded.

**Factory reset.** Full reset of the device. Only the **Factory** calibration remains.

To exit the reset menu, touch the graph image on the screen.



#### 14. WARRANTY

Kroks Plus LLC guarantees the compliance of this product with the technical characteristics specified in this document.

The warranty period is 12 months from the date of purchase of the product by the customer. During this period, the manufacturer provides a free warranty service.

The warranty does not cover the following cases:

- the warranty period of the product has expired from the date of sale;
- more than 12 months have passed from the date of manufacture of the product (only if the product does not have documents confirming the date of sale, such as a sales receipt or a correctly completed warranty card containing information about the product and the seller);
- a product intended for personal needs was used for commercial activities, as well as for other purposes that do not correspond to its intended purpose;
- violation of the rules and operating conditions specified in the «Manual» and other documentation provided to the Buyer complete with the product;
- if the Product contains traces of unqualified repairs or attempts to open it outside an authorized service center, as well as due to unauthorized interference with the software;
- damage (defects) of the Goods caused by the influence of virus programs, interference with the software, or the use of third-party software (non-original);
- the defect is caused by force majeure (for example, earthquake, fire, lightning strike, instability in the electrical network), accidents, deliberate or careless actions of the consumer or third parties;
- mechanical damage (cracks, chips, holes) arising after the transfer of the product to the Buyer;
- damage caused by exposure to moisture, high or low temperatures, corrosion, oxidation, ingress of foreign objects, substances, liquids, insects into the product;
- the defect arose due to the supply of a signal to the input connectors, terminals, case that exceeds the values permissible for this Product;
- the defect is caused by natural wear and tear of the Goods (for example, but not limited to: natural wear and tear of connectors due to frequent plugging / unplugging of adapters).

The warranty only covers defects caused by the fault of the manufacturer. Warranty service is performed by the manufacturer.

I have read the warranty obligations

\_\_\_\_\_  
(Buyer's signature)

Date of sale: \_\_\_\_\_ Seller \_\_\_\_\_  
(date) (store name or stamp)

Country of origin:

Russia



Manufacturer:

LLC "Kroks Plus"

Manufacturer's address:

394005, Voronezh, Moskovsky pr-t 133, office 263

Organization authorized  
to accept claims:

LLC "Kroks Plus", Voronezh,  
st. Vladimir Nevsky, 39b

## APPLICATION A

(informational)

### ARINST VNA-PR1 vector network analyzer software update

Firmware of the vector network analyzer is constantly being improved and optimized. Errors are corrected, additions are made that optimize the operation of the device and have a positive effect on the accuracy of measurements. In addition to fixing errors and stabilizing work, new functionality is being added that expands the scope of the device.

We recommend that you regularly update the device firmware.

#### 1. Installing the boot loader and virtual port driver on your PC

1.1. Go to the official website of ARINST by entering the address [www.arinst.net](http://www.arinst.net) in the address bar of your browser. Go to the **DOWNLOAD** section and click on the file *Arinst Firmware Updater* to update the firmware of vector circuit analyzers (Figure A1. 1).

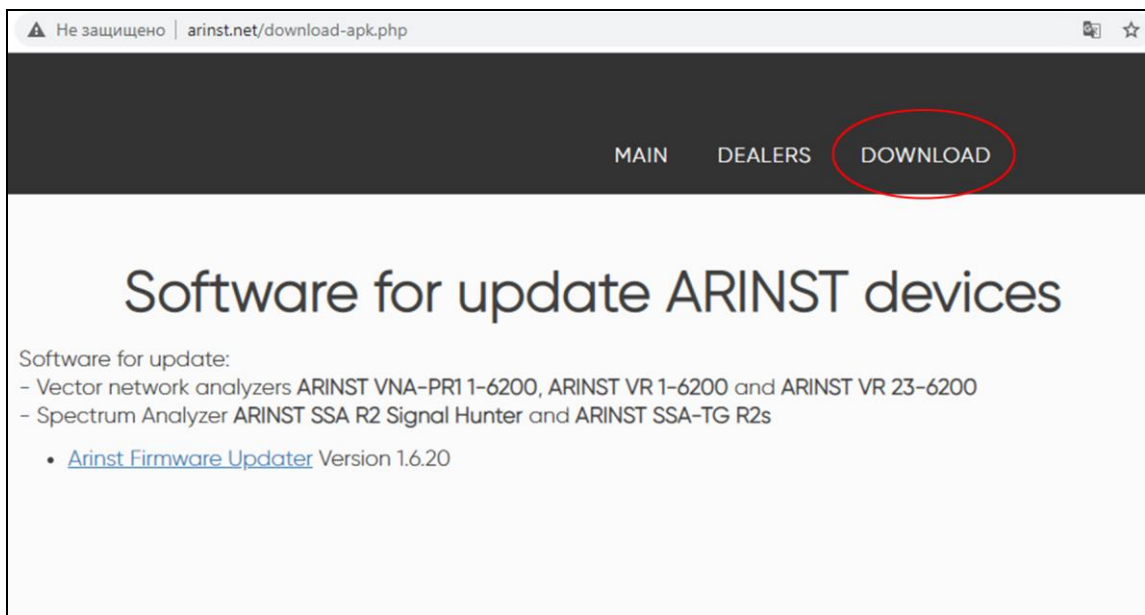

Figure A1.1 - Downloading the application for updating the device

1.3. Enter the directory with the downloaded compressed (archived) file. Unzip the downloaded file using archiving programs (Figure A1.2).

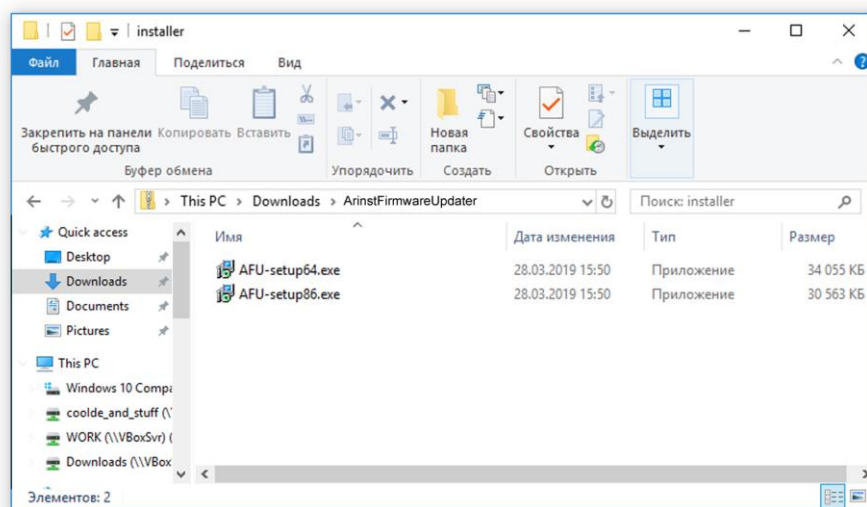

Figure A1.2 - Unzipped downloaded file

The unzipped file contains 2 objects:

- The *AFU-setup64.exe* update loader installation file for 64-bit Windows operating systems.
- The *AFU-setup86.exe* update loader installation file for 32-bit Windows operating systems.

To determine which Windows operating system (32-bit or 64-bit) is installed on your PC, run:

**For Windows 7:**

- Click the **Start** button, right-click **Computer**, and then select **Properties**.
- In the **System** section, see what type of system is listed.

**For Windows 8.1 and Windows 10:**

- Click the **Start** button and select: **Settings** → **System** → **About**.
- In the **Specifications** section, see which System type is listed.

1.4. After selecting the installation file corresponding to the bitness of your operating system, install the update loader on your PC, following the instructions of the installer.

The **Arinst Firmware Updater** application and the virtual COM port driver will be installed.

 **The installer package contains all the necessary components for the correct operation of the application and the connected equipment. If the installation of any components was interrupted by the user, these components must be installed independently or restart the installer package.**

**2. Device firmware update**

 **Before updating the device firmware, make sure that your PC has access to the Internet.**

2.1. Connect the device with a USB cable to the USB port of the PC. Switch on the device.

2.2. Run the application **Arinst Firmware Updater**.

2.3. Click the button <sup>9</sup> to connect the device to your PC (Figure A2.1).

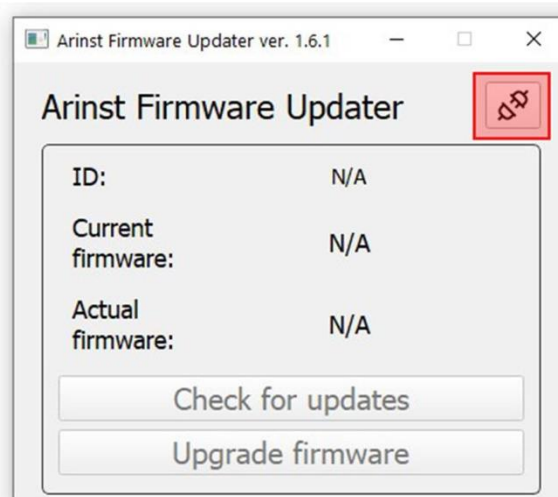

Figure A2.1 - Connecting the device to PC

2.4. In the window that opens, from the drop-down list select the virtual COM port for connecting the device (Figure A2.2).

<sup>9</sup> The command buttons of the loader interface in this application are highlighted in red only for ease of reading.

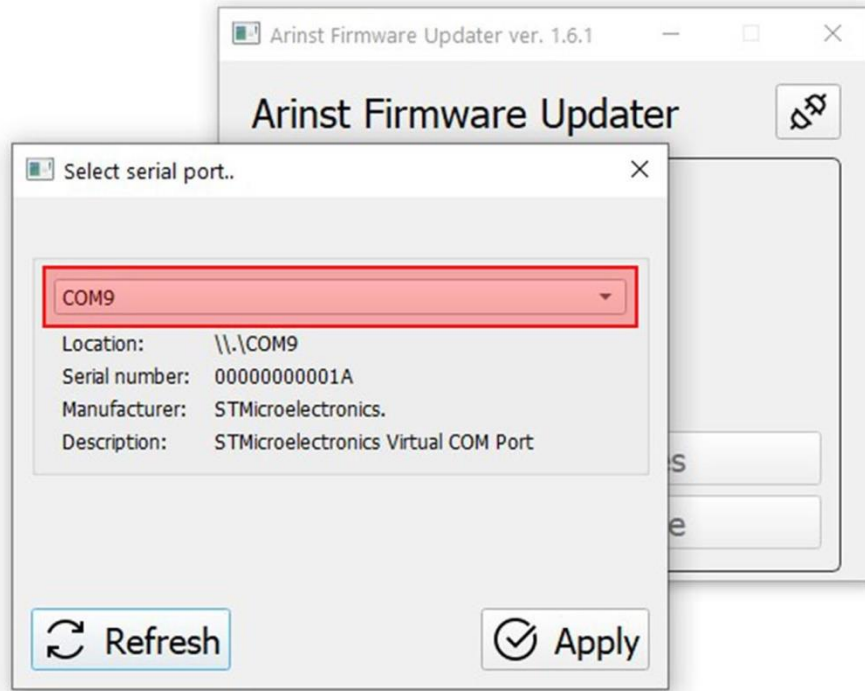

Figure A2.2 - Selecting a virtual COM port for connecting the device

*In our example, in Figure A2.2, the COM9 virtual port is selected.*

2.5. If the desired port is not in the list of virtual ports, click the **Refresh** button.

2.6. After selecting the COM port, connect the device by clicking the **Apply** button.

2.7. After connection, the ID and firmware version of the device will be determined. The **Check for updates** button will become active (Figure A2.3).

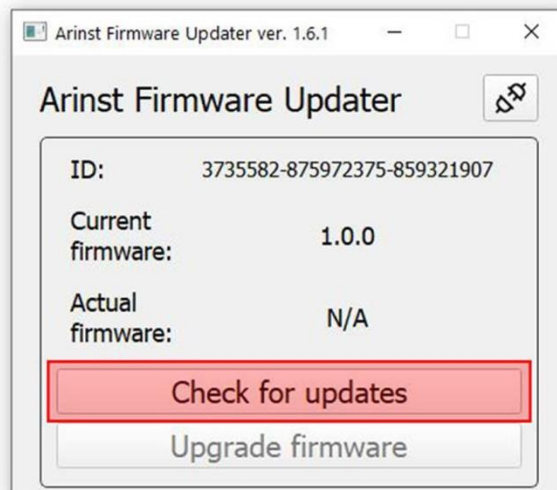

Figure A2.3 - The device is connected to the PC

Click the **Check for updates** button. If the current firmware version is lower than the actual one, the application will offer to update the device's firmware (figure A2. 4).

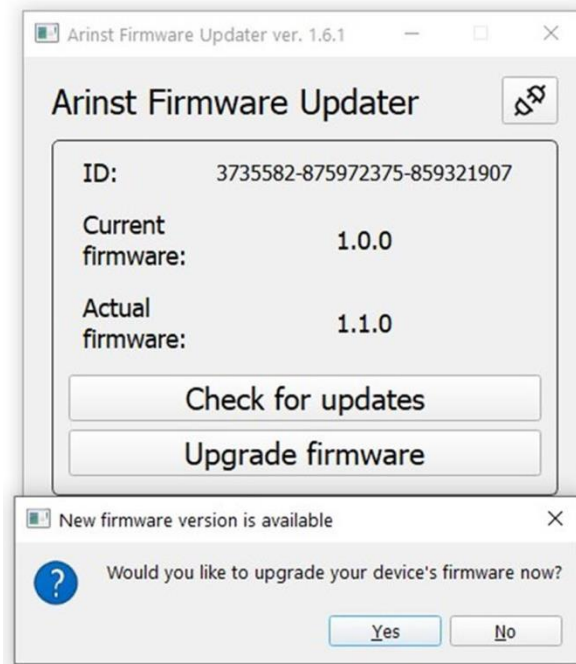

Figure A2.4 - Message about a later firmware version

2.8. To update the device firmware automatically, click **Yes**. If you plan to update the firmware later, click **No**.

To update the device firmware manually, click the **Upgrade firmware** button.

If the device was in application mode, it will automatically restart during the firmware update. The application message will be displayed on the PC screen (figure A2. 5).

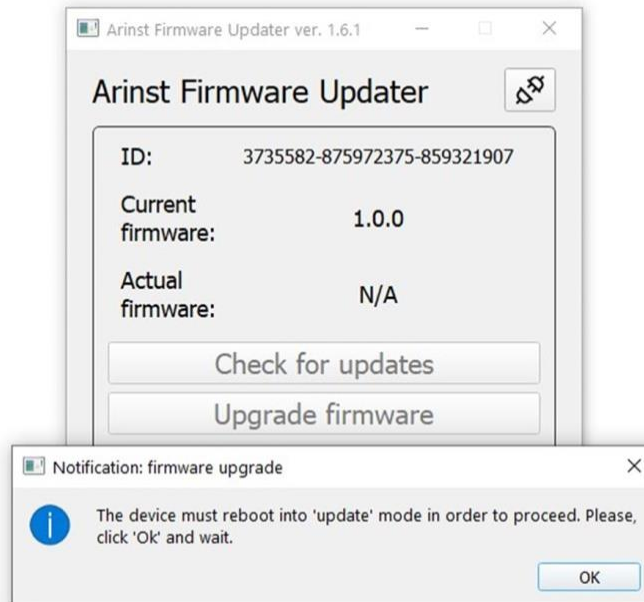

Figure A2. 5 - Application message about the device switching to update mode

2.9. During the device firmware update, a window will appear with the download progress (Figure A2. 6).

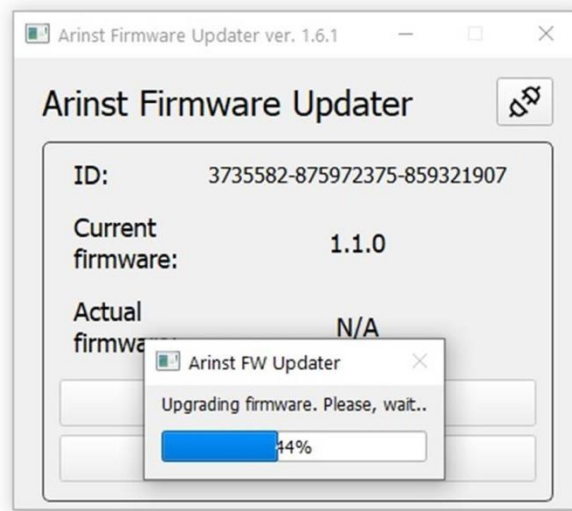

Figure A2.6 - Updates download process

After completing the download of the updates, the device will automatically reboot and switch to the application mode. An application message will be displayed on the PC screen.

2.10. After downloading and installing the new firmware, the application will display the latest installed version of the device software (Figure A2.7)

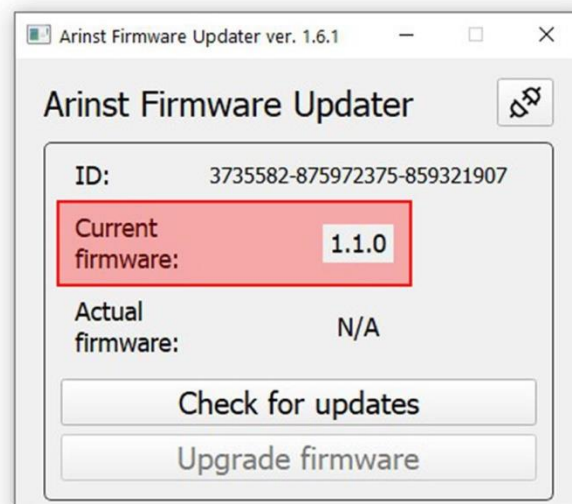

Figure A2.7 - Displaying the device firmware version

To ensure that the latest firmware is installed, click the **Check for updates** button. A message about the latest firmware version will be displayed on the screen.

### 3. Device status messages displayed during the update process

3.1. Standard firmware download without errors. The device screen displays its number and the result of checking the downloaded firmware (Figure A3. 1).

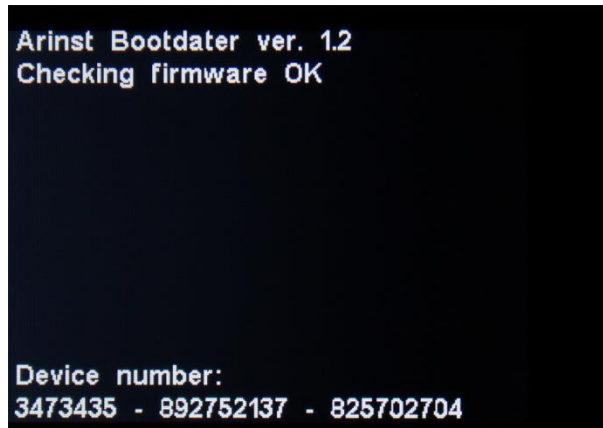

Figure A3. 1 - Successful firmware download

3.2. Unsuccessful firmware download. (Figure A3.2). Connect the device to a PC and update the device firmware again.

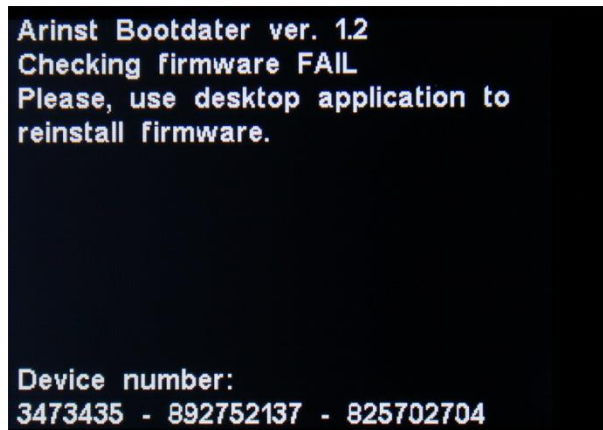

Figure A3.2 - Unsuccessful firmware download

3.3. If the update process was interrupted, the device will start in update mode until the update process is completed. The device displays a message about the update mode in which the device is located (Figure A3.3).

Check the connection of the device to the PC and carry out the firmware update again.

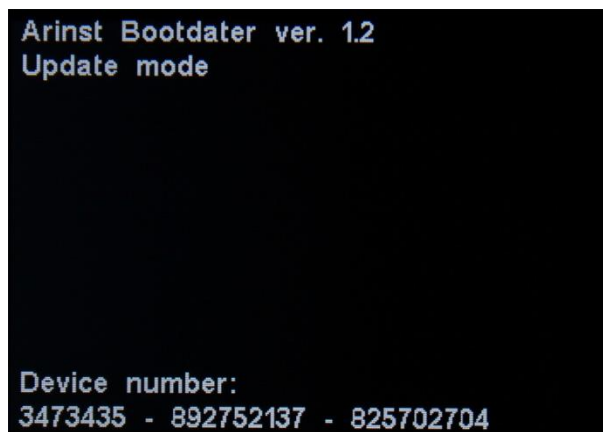

Figure A3.3 - The device is in update mode

3.4. After completing the update process, the device checks the installed firmware. If the checksums do not converge, a mismatch message is displayed on the screen (Figure A3.4). After rebooting, the device will be in the update error mode. Check the connection of the device to the PC and carry out the firmware update again.

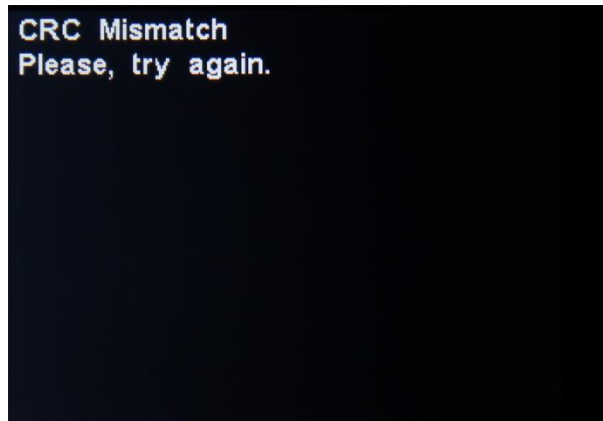

Figure A3.4 - Unsuccessfully installed firmware